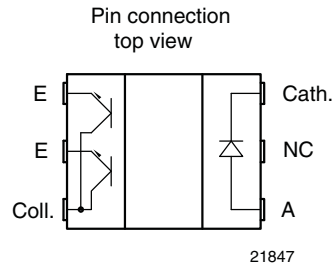


## Subminiature Dual Channel Transmissive Optical Sensor with Phototransistor Outputs



19534



21847

### DESCRIPTION

The TCUT1300X01 is a compact transmissive sensor that includes an infrared emitter and two phototransistor detectors, located face-to-face in a surface mount package.

### FEATURES

- Package type: surface mount
- Detector type: phototransistor
- Dimensions (L x W x H in mm): 5.5 x 4 x 4
- AEC-Q101 qualified
- Gap (in mm): 3
- Aperture (in mm): 0.3
- Channel distance (center to center): 0.8 mm
- Typical output current under test:  $I_C = 0.6$  mA
- Emitter wavelength: 950 nm
- Lead (Pb)-free soldering released
- Moisture sensitivity level (MSL): 1
- Compliant to RoHS Directive 2002/95/EC and in accordance to WEEE 2002/96/EC



### APPLICATIONS

- Automotive optical sensors
- Accurate position sensor for encoder
- Sensor for motion, speed and direction

PRODUCT SUMMARY				
PART NUMBER	GAP WIDTH (mm)	APERTURE WIDTH (mm)	TYPICAL OUTPUT CURRENT UNDER TEST <sup>(1)</sup> (mA)	DAYLIGHT BLOCKING FILTER INTEGRATED
TCUT1300X01	3	0.3	0.6	No

#### Note

<sup>(1)</sup> Conditions like in table basic characteristics/coupler

ORDERING INFORMATION			
ORDERING CODE	PACKAGING	VOLUME <sup>(1)</sup>	REMARKS
TCUT1300X01	Tape and reel	MOQ: 2000 pcs, 2000 pcs/reel	Drypack, MSL 1

#### Note

<sup>(1)</sup> MOQ: minimum order quantity

\*\* Please see document "Vishay Material Category Policy": [www.vishay.com/doc?99902](http://www.vishay.com/doc?99902)



<b>ELECTRICAL CHARACTERISTICS</b> ( $T_{amb} = 25\text{ }^{\circ}\text{C}$ , unless otherwise specified)						
PARAMETER	TEST CONDITION	SYMBOL	MIN.	TYP.	MAX.	UNIT
<b>COUPLER</b>						
Collector current per channel	$V_{CE} = 5\text{ V}$ , $I_F = 15\text{ mA}$	$I_C$	300	600		$\mu\text{A}$
Collector emitter saturation voltage	$I_F = 15\text{ mA}$ , $I_C = 0.05\text{ mA}$	$V_{CEsat}$			0.4	V
<b>INPUT (EMITTER)</b>						
Forward voltage	$I_F = 15\text{ mA}$	$V_F$	1	1.2	1.4	V
Reverse current	$V_R = 5\text{ V}$	$I_R$			10	$\mu\text{A}$
Junction capacitance	$V_R = 0\text{ V}$ , $f = 1\text{ MHz}$	$C_j$		25		pF
<b>OUTPUT (DETECTOR)</b>						
Collector emitter voltage $I_C$	$I_C = 1\text{ mA}$	$V_{CEO}$	20			V
Emitter collector voltage	$I_E = 100\text{ }\mu\text{A}$	$V_{ECO}$	7			V
Collector dark current	$V_{CE} = 25\text{ V}$ , $I_F = 0\text{ A}$ , $E = 0\text{ lx}$	$I_{CEO}$		1	100	nA
<b>SWITCHING CHARACTERISTICS</b>						
Rise time	$I_C = 0.3\text{ mA}$ , $V_{CE} = 5\text{ V}$ , $R_L = 100\text{ }\Omega$ (see fig. 3)	$t_r$		20	150	$\mu\text{s}$
Fall time	$I_C = 0.3\text{ mA}$ , $V_{CE} = 5\text{ V}$ , $R_L = 100\text{ }\Omega$ (see fig. 3)	$t_f$		30	150	$\mu\text{s}$

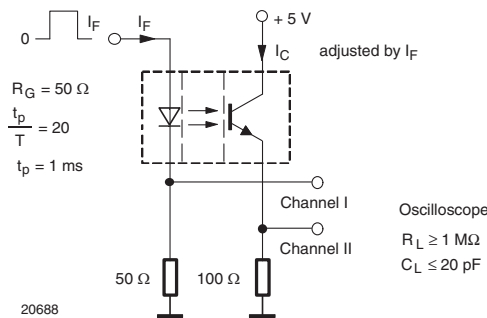
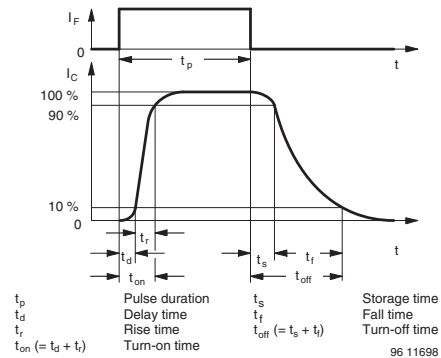

 Fig. 3 - Test Circuit for  $t_r$  and  $t_f$ 


Fig. 4 - Switching Times

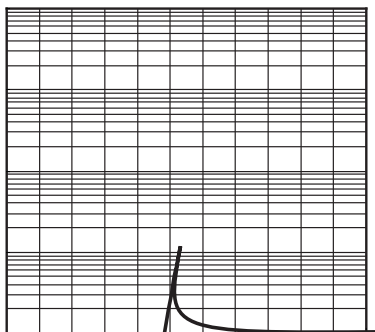
**BASIC CHARACTERISTICS** ( $T_{amb} = 25\text{ }^{\circ}\text{C}$ , unless otherwise specified)


Fig. 5 - Forward Current vs. Forward Voltage

Fig. 6 - Forward Voltage vs. Ambient Temperature

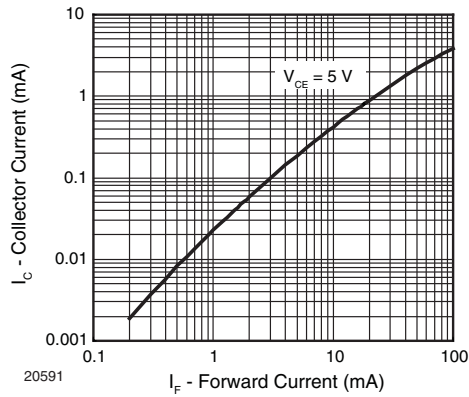


Fig. 7 - Collector Current vs. Forward Current

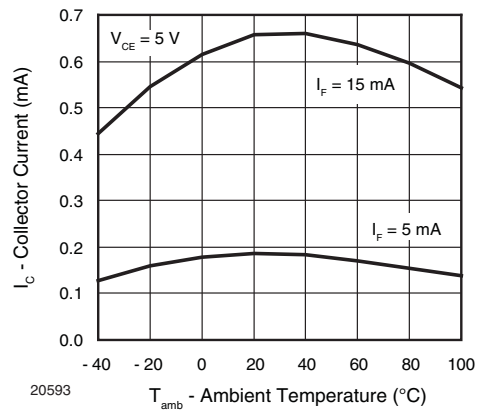


Fig. 10 - Collector Current vs. Ambient Temperature

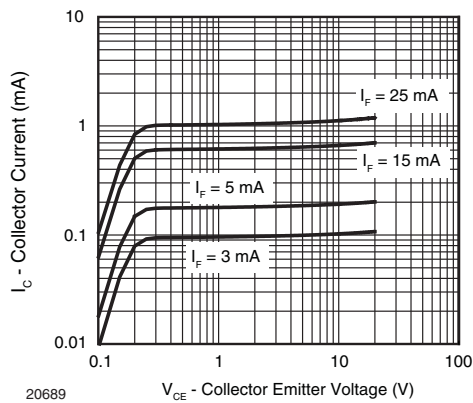


Fig. 8 - Collector Current vs. Collector Emitter Voltage

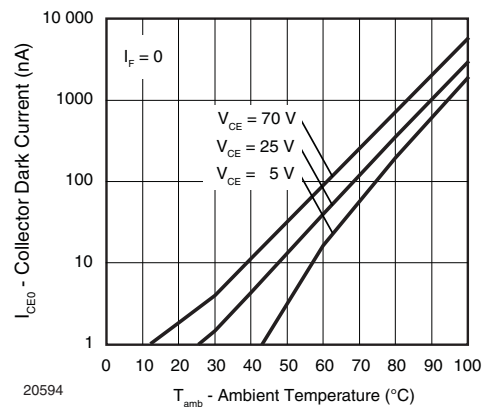


Fig. 11 - Collector Dark Current vs. Ambient Temperature

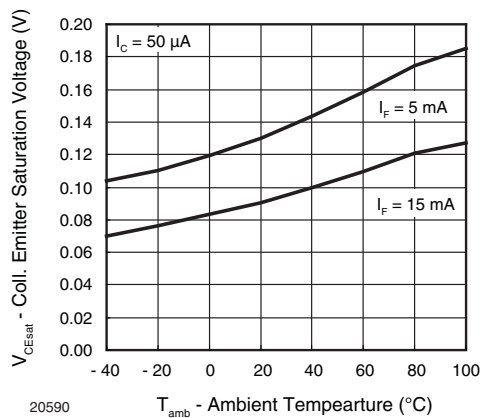


Fig. 9 - Collector Emitter Saturation Voltage vs. Ambient Temperature

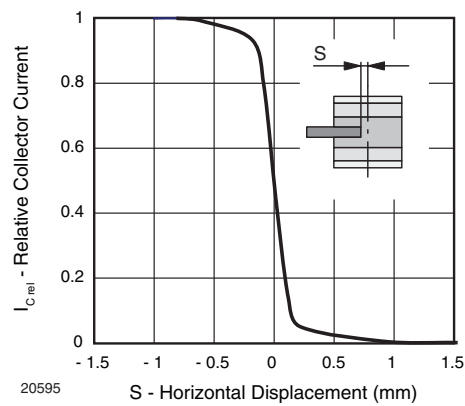


Fig. 12 - Relative Collector Current vs. Horizontal Displacement

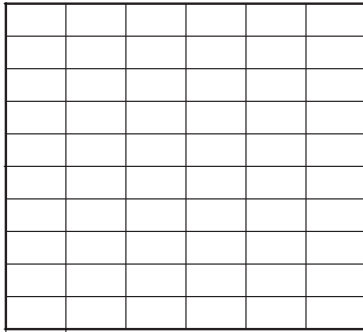


Fig. 13 - Relative Collector Current vs. Vertical Displacement

Fig. 15 - Application example

**REFLOW SOLDER PROFILE**

Fig. 14 - Rise/Fall Time vs. Collector Current

Fig. 16 - Lead (Pb)-free Reflow Solder Profile acc. J-STD-020

**FLOOR LIFE**

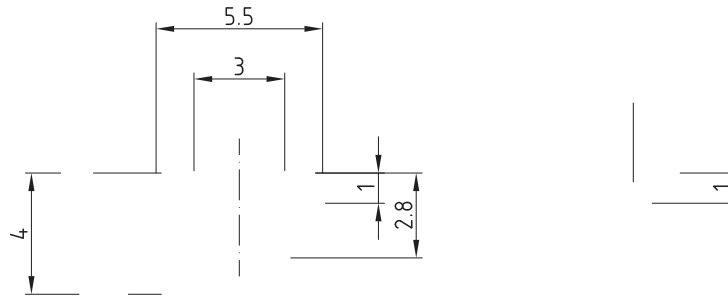
Level 1, acc. JEDEC, J-STD-020. No time limit.

# TCUT1300X01



Vishay Semiconductors Subminiature Dual Channel Transmissive  
Optical Sensor with Phototransistor Outputs

**PACKAGE DIMENSIONS** in millimeters

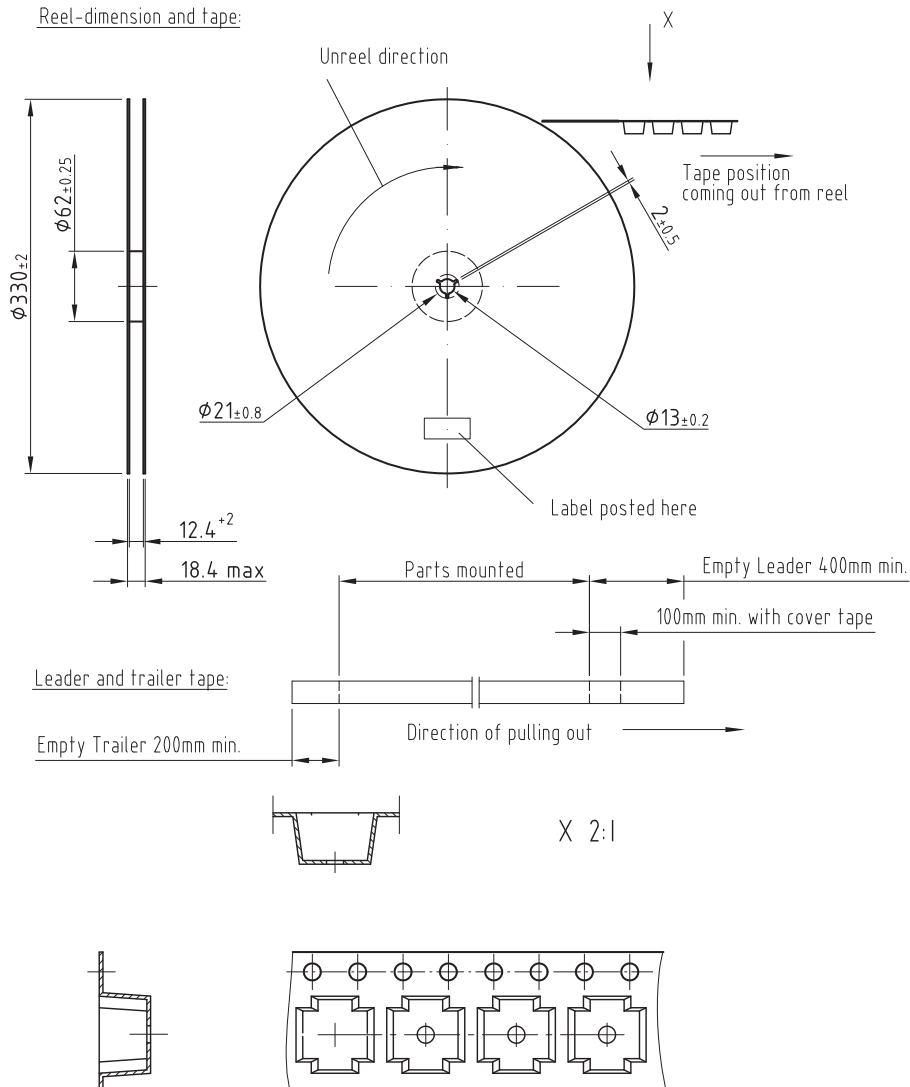




Subminiature Dual Channel Transmissive Optical Sensor with Phototransistor Outputs Vishay Semiconductors

**PACKAGE DIMENSIONS** in millimeters

Volume/reel = 2000 pcs



Drawing-No.: 9.800-5092.01-4

## Packaging and Ordering Information

PART NUMBER	MOQ <sup>(1)</sup>	PCS PER TUBE	TUBE SPEC. (FIGURE)	CONSTITUENTS (FORMS)
CNY70	4000	80	1	28
TCPT1300X01	2000	Reel	(2)	29
TCRT1000	1000	Bulk	-	26
TCRT1010	1000	Bulk	-	26
TCRT5000	4500	50	2	27
TCRT5000L	2400	48	3	27
TCST1030	5200	65	5	24
TCST1030L	2600	65	6	24
TCST1103	1020	85	4	24
TCST1202	1020	85	4	24
TCST1230	4800	60	7	24
TCST1300	1020	85	4	24
TCST2103	1020	85	4	24
TCST2202	1020	85	4	24
TCST2300	1020	85	4	24
TCST5250	4860	30	8	24
TCUT1300X01	2000	Reel	(2)	29
TCZT8020-PAER	2500	Bulk	-	22

### Notes

(1) MOQ: minimum order quantity

(2) Please refer to datasheets

### TUBE SPECIFICATION FIGURES

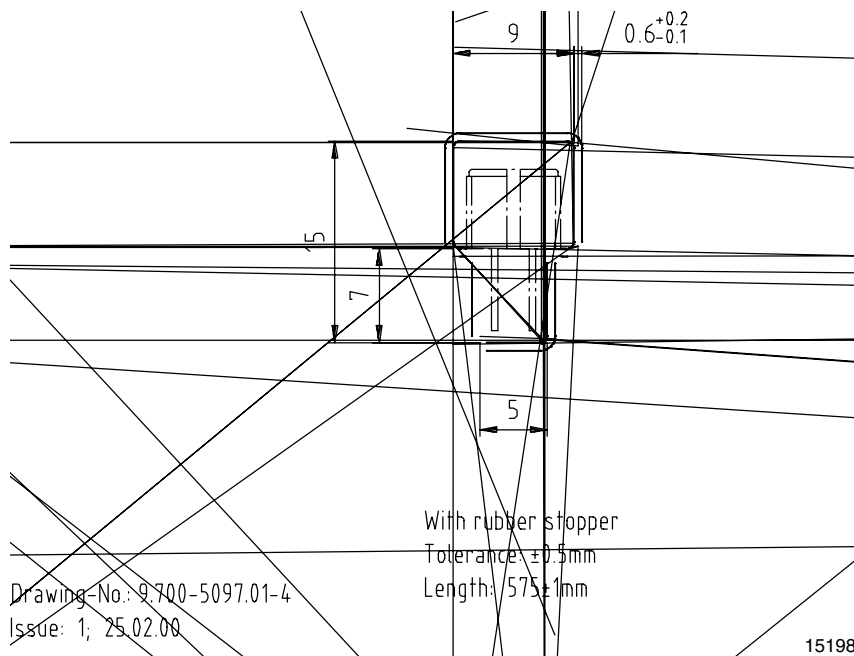


Fig. 1



# Packaging and Ordering Information

Vishay Semiconductors Packaging and Ordering Information

---



15210

Fig. 2

Fig. 3



With rubber stopper  
Tolerance: ±0.5mm  
Length: 575±1mm

Drawing-No.: 9.700-5100.01-4  
Issue: 1; 25.02.00

15199

Fig. 4



With stopper pins  
Tolerance: ±0.5mm  
Length: 575±1mm

Drawing-No.: 9.700-5140.01-4  
Issue: 1; 25.02.00

15202

Fig. 5



Drawing-No.: 9.700-5205.01-4  
Issue: 1; 25.02.00

15196

Fig. 6



Drawing-No.: 9.700-5245.01-4  
Issue: 1; 25.02.00

15195

Fig. 7



Drawing-No.: 9.700-5222.01-4  
 Issue: 2; 19.11.04  
 20257

With stopper pins  
 Tolerance:  $\pm 0.5\text{mm}$   
 Length:  $450 \pm 1\text{mm}$   
 All dimensions in mm

Fig. 8



## Disclaimer

ALL PRODUCT, PRODUCT SPECIFICATIONS AND DATA ARE SUBJECT TO CHANGE WITHOUT NOTICE TO IMPROVE RELIABILITY, FUNCTION OR DESIGN OR OTHERWISE.

Vishay Intertechnology, Inc., its affiliates, agents, and employees, and all persons acting on its or their behalf (collectively, "Vishay"), disclaim any and all liability for any errors, inaccuracies or incompleteness contained in any datasheet or in any other disclosure relating to any product.

Vishay makes no warranty, representation or guarantee regarding the suitability of the products for any particular purpose or the continuing production of any product. To the maximum extent permitted by applicable law, Vishay disclaims (i) any and all liability arising out of the application or use of any product, (ii) any and all liability, including without limitation special, consequential or incidental damages, and (iii) any and all implied warranties, including warranties of fitness for particular purpose, non-infringement and merchantability.

Statements regarding the suitability of products for certain types of applications are based on Vishay's knowledge of typical requirements that are often placed on Vishay products in generic applications. Such statements are not binding statements about the suitability of products for a particular application. It is the customer's responsibility to validate that a particular product with the properties described in the product specification is suitable for use in a particular application. Parameters provided in datasheets and/or specifications may vary in different applications and performance may vary over time. All operating parameters, including typical parameters, must be validated for each customer application by the customer's technical experts. Product specifications do not expand or otherwise modify Vishay's terms and conditions of purchase, including but not limited to the warranty expressed therein.

Except as expressly indicated in writing, Vishay products are not designed for use in medical, life-saving, or life-sustaining applications or for any other application in which the failure of the Vishay product could result in personal injury or death. Customers using or selling Vishay products not expressly indicated for use in such applications do so at their own risk and agree to fully indemnify and hold Vishay and its distributors harmless from and against any and all claims, liabilities, expenses and damages arising or resulting in connection with such use or sale, including attorneys fees, even if such claim alleges that Vishay or its distributor was negligent regarding the design or manufacture of the part. Please contact authorized Vishay personnel to obtain written terms and conditions regarding products designed for such applications.

No license, express or implied, by estoppel or otherwise, to any intellectual property rights is granted by this document or by any conduct of Vishay. Product names and markings noted herein may be trademarks of their respective owners.