

Handheld Digital Multimeter

GDM-350B

USER MANUAL



ISO-9001 CERTIFIED MANUFACTURER

Good Will Instrument Co., Ltd. No. 7-1, Jhongsing Rd., Tucheng Dist., New Taipei City 236, Taiwan.

Table of Contents

O VERVIEW.....	2
Unpacking & Inspection	3
Safety Information.....	4
International Electrical Symbols	6
Overall Specification	7
The Meter Structure	8
M EASUREMENT OPERATION.....	9
DC or AC Voltage Measurement	10
DC Current Measurement	12
Resistance Measurement	14
Diode Measurement	16
Continuity Measurement	18
Transistor hFE measurement	20
Temperature Measurement.....	22
A CCURACY SPECIFICATIONS.....	24
M AINTENANCE	30
General Service and Maintenance.....	30
Replacing the Battery and Fuse	31

OVERVIEW

⚠ Warning

To avoid electric shock or personal injury, read the “Safety Information” carefully before using the Meter.

Unpacking & Inspection

Item	Description	Qty
1	Operating Manual	1 piece
2	Test Leads	1 pair
3	K-type Temperature Probe (Nichrome-Nickel Aluminum Thermocouple)	1 piece
4	Multi-Purpose Socket	1 piece

Safety Information

he battery indicator “”

International Electrical Symbols



Overall Specification

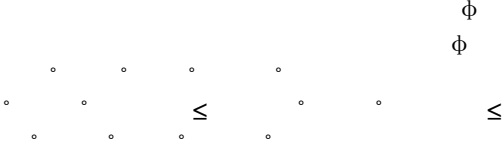

The Meter Structure

1. LCD Display
2. Power Button
3. Rotary Switch
4. Input Terminals
5. HOLD Button

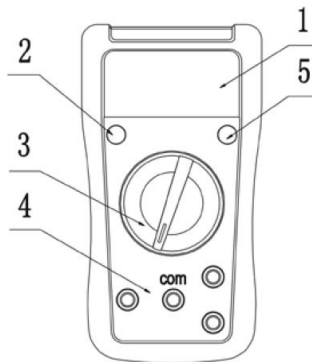

diagram 1

M EASUREMENT OPERATION



DC or AC Voltage Measurement

Diagram 2



Insert the red test lead into the “V” terminal and the black test lead into the “COM” terminal, Connect the test leads

each range, the meter has an input impedance of $10\text{M}\Omega$.

~ is about $4.5\text{M}\Omega$

. If the circuit impedance is less than or equal to $10k\Omega$,

⚠ Warning:

- **To avoid damage to the meter, please do not attempt to input more than 250V.**
- **To avoid electrical shock, please pay attention during high voltage measurement.**

DC Current Measurement

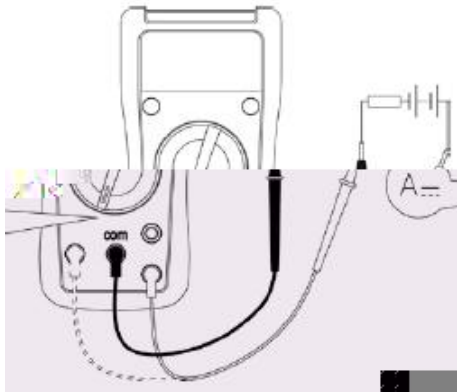

Diagram 3

“A ”

Insert the red test lead into the “mA” or “10A” terminal, and the black test lead
“ ”

⚠ Warning:

- **Pre-requisites: Remove the power from the circuit before connecting the test leads to the DUT.**
- **Select the correct terminal input and turn the rotary switch to select the measurement function. If the correct range is not known, select the highest range and work your way down to a lower range if needed.**
- **Fuses are located on the mA and 10A current input terminals. Never attempt connecting the test leads to any circuits that are connected to mains power.**
- **For safety purposes, ensure each measurement over 5A is performed for less than 10 seconds with a 15 minute interval between measurements.**

Resistance Measurement

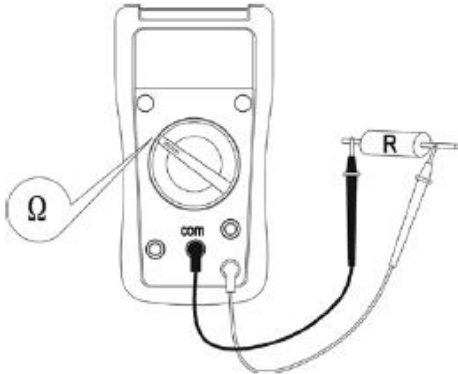

Diagram 4

“Ω”

Insert the red test lead into the “Ω” terminal and the black test lead into the “COM” terminal. Conne

⚠ Warning:

- If the LCD displays “1”, it indicates the circuit is open or that the resistance exceeds the maximum range of the meter.
- To maintain the resistance measurement accuracy, remove circuit power and discharge all high voltage capacitors when measuring resistance.

The test leads cause a resistance drop of $0.1\Omega \sim 0.2\Omega$. In order to obtain precise readings for low-resistance measurements, the resistance of the test leads must be deducted from the measured resistance. Short the test leads and note the measurement result. Deduct this value from the resistance of the DUT.

Measured Result of DUT - Resistance of test leads = Actual measurement.

- If a resistance reading with shorted test leads is not less than or equal to 0.5Ω , check for possible problems such as loose test leads or an incorrectly selected function.
- For resistance measurements greater than $1M\Omega$, it may take several seconds to obtain a stable reading.
- Do not input greater than DC 60V and AC 30V to prevent damage and injury.

Diode Measurement

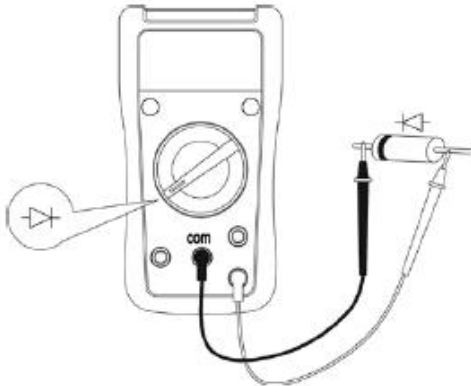



Diagram 5

“COM” terminal. “ ” terminal and the black test lead into the red test lead is “+” black test lead is “-”

⚠ Warning:

- The LCD displays “1” to indicate that the circuit is open or that the polarity of the diode is incorrect.
- To ensure the accuracy of the diode measurement, disconnect power from the circuit and discharge all high voltage capacitors during the measurement.
- The open circuit voltage for diodes is 2.3V.
- Do not input greater than DC 60V and AC 30V to prevent damage and injury.

"") "
"ΩmA"

"COM" term

Ω

≤ Ω

Ω

Warning:

- To maintain measurement accuracy, disconnect circuit power and discharge all the high voltage capacitors during continuity measurement.
- For continuity testing, the open circuit for voltage is 2.3V.
- Do not input higher than DC 60V and AC 30V voltage to prevent any damage and injury.

Transistor hFE measurement

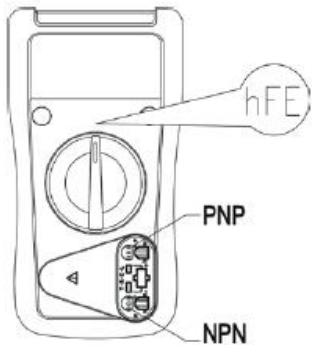

Diagram 7

“hFE”

N

 **Warning:**

- To avoid damage to the Meter or to the DUT, do not input any voltage over

Temperature Measurement



Diagram 8

“°C”

°

°

“ ”

°

 **Warning:**

- **Keep the thermocouple clean to prevent the contact point from having any serious influence on measurements.**
- **Remove the contact point after temperature measurement and store in good condition.**

A

CCURACY SPECIFICATIONS

. .

DC Voltage

Range	Resolution	Accuracy
200mV	0.1mV	±(0.5% Reading + 2 Digits)
2000mV	1mV	
20V	0.01V	
200V	0.1V	
250V	1V	±(0.8% Reading + 2 Digits)

Input impedance: all range 10MΩ

AC Voltage

Range	Resolution	Accuracy
200V	0.1V	±(1.2 Reading% +3 Digits)
250V	1V	

Input impedance: about 4.5M Ω ;

DC Current

Range	Resolution	Accuracy
2000 μ A	1 μ A	\pm (1% Reading +2 Digits)
20mA	0.01mA	\pm (1% Reading + 2 Digits)
200mA	0.1mA	\pm (1.2% Reading +2 Digits)
10A	0.01A	\pm (2% Reading +5 Digits)

 $\phi \times$ $\phi \times$ ** Warning:****When $\leq 5A$ Continuous measurement is allowed.****When $> 5A$ Measurements must not take longer than 10 seconds with a wait of 15 minutes between measurements.**

Resistance

Range	Resolution	Accuracy
200 Ω	0.1 Ω	$\pm(0.8\% \text{ Reading} + 5 \text{ Digits})$
2000 Ω	1 Ω	
20k Ω	0.01k Ω	
200k Ω	0.1k Ω	
2000k Ω	1k Ω	
20M Ω	0.01M Ω	$\pm(1\% \text{ Reading} + 5 \text{ Digits})$

Temperature Measurement

Range	Resolution	Accuracy
-40°C ~ -20°C	1°C	-(8% Reading + 5 digits)
-20°C ~ 0°C		± 4 digits
> 0°C ~ 100°C		±(1.0% Reading + 3 digits)
> 100°C ~ 1000°C		±(2.5% Reading + 2 digits)

Diode, Transistor

Function	Range	Resolution	Remark
Diode		1mV	Display positive voltage decline
Transistor	hFE	1 β	

Continuity Test

Function	Range	Resolution	Remark
Continuity Test		1 Ω	<10 Ω Buzzer beeps continuously

M AINTENANCE

Warning

Make sure the test leads are removed and the power is turned off the meter before opening the cover.

General Service and Maintenance

-
-
-

Replacing the Battery and Fuse

Warning

On the LCD display, the battery warning indicator, “” indicates the battery is low and needs to be replaced with a new battery. Failure to replace the battery causes the measured result to be unstable.

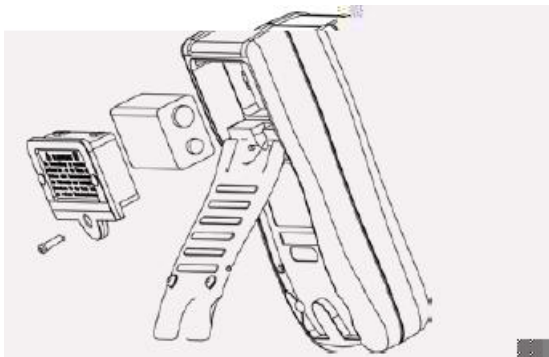

Φ

Φ