

# Handheld LCR Meter

LCR-1100/1010

---

## USER MANUAL

Rev. 1.00



ISO-9001 CERTIFIED MANUFACTURER

**GW INSTEK**

This manual contains proprietary information, which is protected by copyright. All rights are reserved. No part of this manual may be photocopied, reproduced or translated to another language without prior written consent of Good Will company.

The information in this manual was correct at the time of printing. However, Good Will continues to improve products and reserves the rights to change specification, equipment, and maintenance procedures at any time without notice.

Good Will Instrument Co., Ltd.

No. 7-1, Jhongsing Rd., Tucheng Dist., New Taipei City 236, Taiwan.

# Table of Contents

<b>SAFETY INSTRUCTIONS</b> .....	<b>5</b>
<b>GETTING STARTED</b> .....	<b>9</b>
LCR-1000 Series Overview .....	9
Appearance .....	12
Main Specifications and Features .....	15
Connection of test terminal .....	19
Battery installation and replacement .....	20
Battery and Power supply .....	21
<b>MEASURE</b> .....	<b>23</b>
FUNC .....	24
FREQ.....	24
LEVEL.....	25
RANGE .....	25
EQU .....	26
SPEED .....	26
<b>SETUP</b> .....	<b>27</b>
AUTO LCZ .....	28
COMP .....	28
BEEP .....	29
NOMINAL .....	29
TOL( $\pm$ ) .....	31
<b>OPEN/SHORT</b> .....	<b>32</b>
Open test .....	33
Short test .....	35
<b>SYSTEM CONFIG</b> .....	<b>37</b>
KEY BEEP .....	38

BRIGHTNESS .....	38
TOUCH PANEL.....	39
DIM DISPLAY .....	42
APO.....	42
VCOM ENDMARK.....	43
USB-HID PID.....	44
DEFAULT SET .....	45
SYSTEM INFORMATION .....	46

**MEASUREMENT EXAMPLES..... 47****REMOTE CONTROL..... 49**

Connect to PC to ensure measurement accuracy .....	49
USB-VCOM virtual serial port .....	50
USB-HID device class .....	51

**COMMAND OVERVIEW .....** 54

USB-HID command package .....	54
Specifiers .....	55
Data types .....	56
Command List .....	57
Commands .....	59

**SPECIFICATIONS..... 68**

Specifications .....	68
General Characteristics .....	68
Accuracy.....	70
Dimensions .....	76

# S SAFETY INSTRUCTIONS

Read the following before any operation to ensure your safety and to keep the instrument in the best possible condition.

## Safety Symbols

These safety symbols may appear in this manual or on the instrument.

---



Risk of electric shock



See instruction manual



Battery



Fuse



Earth



Do not discard this product or throw away.

---

## Safety Guidelines

---

### General Guideline



### CAUTION

- AC or DC Voltage input is strictly prohibited.
  - Discharge capacitor before testing
  - Do not place any heavy object on the instrument.
  - When testing, the inductance should avoid generating induced current, which may cause damage to the instrument.
  - Avoid severe impact or rough handling that can lead to damaging the instrument.
  - If the equipment is used in a manner not specified by the manufacturer, the protection provided by the equipment may be impaired.  

(Note) EN 61010-1 specifies the measurement categories and their requirements as follows. The LCR-1000 Series doesn't fall under category II, III or IV.
  - Measurement category IV is for measurement performed at the source of low-voltage installation.
  - Measurement category III is for measurement performed in the building installation.
  - Measurement category II is for measurement performed on the circuits directly connected to the low voltage installation.
-

## Power Supply



## WARNING

- The instrument is powered by an internal LI-ION battery for operation.
  - You can use the USB power adapter to connect the instrument to the USB port (Type-C) to charge the internal LI-ION battery.
  - The minimum output of the USB power adapter is 5VDC, 2A.
  - **The USB power adapter must comply with CE regulations to ensure the safety of charging the instrument.**
- 

## Battery



## WARNING

There is a rechargeable lithium battery in the product. Please read all safety information carefully to avoid battery heating, explosion, fire and serious personal injury caused by incorrect use.

- **Please use the original lithium battery (LCR-305) to ensure the safety of the instrument. Using non-original batteries may cause danger to the user or damage the instrument.**
  - Do not use this product in direct sunlight for a long time.
  - Do not use or store this product in a car in hot weather.
  - Do not continue charging after charging is complete.
  - Do not put this product near a fire source, and do not throw this product into a fire.
  - Do not attempt to charge the battery with a damaged charger.
- 

## Cleaning the Instrument

- Disconnect the USB cord before cleaning.
  - Do not clean the inside of the instrument.
  - Use a soft cloth dampened in a solution of mild detergent and water. Do not spray any liquid.
-

- Operation Environment
- Location: Indoor, no direct sunlight, dust free, almost non-conductive pollution (Note below)
  - Temperature: 10°C to 40°C
  - Humidity: 10% to 70%RH(non-condensing)
  - Altitude: <2000m
- 

- Storage environment
- Location: Indoor
  - Temperature: -10°C to 70°C
  - Humidity: <80%RH(non-condensing)
- 

Disposal



Do not dispose this instrument as unsorted municipal waste. Please use a separate collection facility or contact the supplier from which this instrument was purchased. Please make sure discarded electrical waste is properly recycled to reduce environmental impact.

---



# G E T T I N G   S T A R T E D

Introduce LCR-1000 SERIES, including models, package accessories, main features and specifications, front/rear panels, test lead connections, battery installation and replacement.

## LCR-1000 Series Overview

### Series lineup

The LCR-1000 series consists of 2 models.

Model name	Basic accuracy	Test speed	Interface
LCR-1000 Series	±0.2%	10 times/s	USB

Model name	Measurement frequency
LCR-1100	DC, 50/100/120/1k/2k/10k/50k/100kHz
LCR-1010	DC, 50/100/120/1k/2k/10kHz

## Characteristics

---

Thank you for using LCR-1000 Series handheld LCR Meter as your testing instrument. This Manual contains the detailed installation steps. To ensure personnel safety and to protect your equipment and data, please check if the following accessories are fully supplied before starting the installation.

LCR-1000 Series is a handheld precision testing instrument with automatic real-time detection controlled by a high-performance microprocessor. The instrument uses true-color TFT-LCD, operates with keyboard and touch screen, high-precision measurement and easy-to-use.

The instrument can provide the highest test frequency of 100kHz (LCR-1100), and provide 0.3/0.7/1.0Vrms signal level, automatic measurement of inductance L, capacitance C, resistance value R, complex impedance Z, quality factor Q, loss angle Tangent D, phase and Rdc.

50,000 count display primary and secondary parameters are displayed, and the basic accuracy is 0.2%, so that this instrument can meet the requirements of various component manufacturers, schools, research institutes and metrology quality inspection departments for accurate testing.

The instrument provides the sorting function of the tolerance mode, and provides a set of main parameter percentage sorting.

The whole series of instruments are equipped with USB-HID and USB-VCOM interfaces as standard. The computer remote control commands open to users are compatible with SCPI (Standard Command for Programmable Instrument standard command set), and users can write computer software independently to complete remote control efficiently and data collection functions.

---

## Package Contents

Check the contents before using the instrument

Standard Accessories	Part	Description
	LCR-1000	Handheld LCR Meter
	Manual	User Manual
	Safety	Safety Instruction Sheet
	LCR-100	Short circuit bar
	LCR-101	Test Fixture (Kelvin Clip)
	LCR-108	Test Fixture (Tweezers) (GBT-1100 only)
	LCR-205	USB Cable Type A-C
	LCR-305	Lithium battery
	LCR-503	Carrying bag

LCR-1010 Option Accessories	Part	Description
	LCR-108	Test Fixture (Tweezers)

# Appearance

## Front Panel

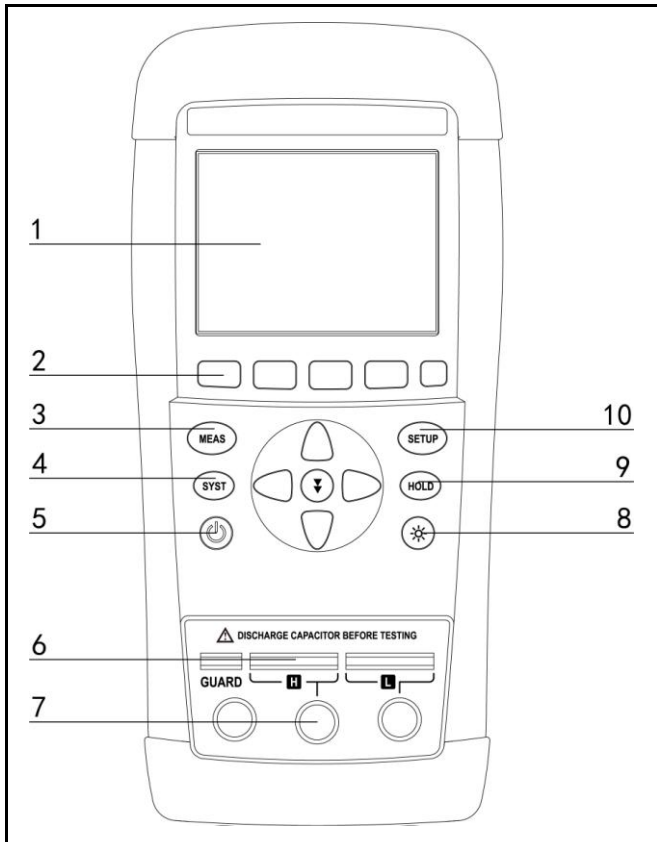

- 1 LCD TFT LCD
- 2 Function For executing the function indicated for the position corresponding to the Function key.  
Soft keys for selecting the

---

		corresponding option located below the LCD screen.
3	Measure	This key is used for entering the measurement display area page.
4	System	This key is used for entering system setup page.
5	Power	<p>Press the power button for about 2 seconds, the instrument will turn on, the green light of the power button will be on, and the battery power is used.</p> <p>Press the power button for about 0.5s, the instrument will shut down and the button light will go out.</p> <p>When the USB is inputting external power, the power button lights up in red and the external power is used.</p>
6	Test Socket	Five-wire terminal test socket
7	Test Jack	Three-wire terminal test jack
8	Backlight Local	<p>Backlight brightness adjustment - 2 levels of backlight display, 50% and 100%</p> <p>This key is also used as an unlock key when the keypad is locked in remote control.</p>
9	Hold	When "H" is displayed on the display, it means that the displayed value is frozen.
10	Setup	This key is used to enter setup page.

---

## Top Panel

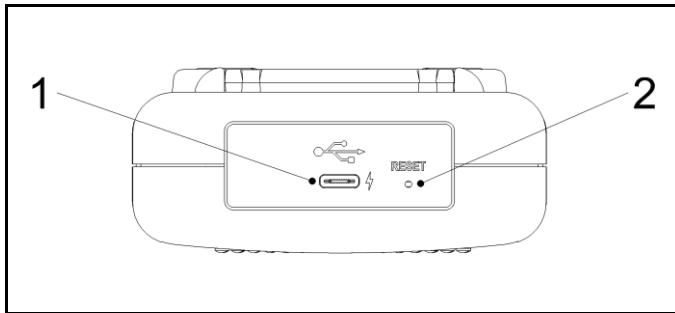

- 
- |   |       |   |
|---|-------|---|
| 1 | USB   | USB port (Type C)<br>This port is used for remote control and battery charging.<br>Using an external power supply, the measurement accuracy will not be guaranteed. |
| 2 | Reset | When the instrument unexpectedly fails to shut down or freezes, reset and restart the instrument.   |
-

## Main Specifications and Features

### Test Function

C-D, C-Q, C-R, L-D, L-Q, L-R, L-Rdc,  
R-Q, R-X, R-Rdc, Rdc, Z-D, Z-Q, Z-θr, Z-θd

### Equivalent Circuit

Series (subscript s), parallel (subscript p).  
Actual capacitors, inductors, and resistors are not ideal components of pure reactance and pure resistance. They usually have both resistive and reactive components. An actual impedance element can be simulated by an ideal resistor and an ideal reactor (inductance or capacitance) in series or in parallel.  
It can be converted mathematically with a formula, but the two forms are different, and the inconsistency depends on the quality factor Q (or loss D).

Table 2-1

Equivalent Circuit

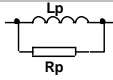
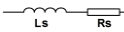
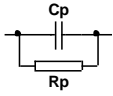
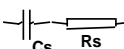
	Circuit	Dissipation Factor	Conversion
L		$D=2\pi FLp/Rp=1/Q$	$Ls=Lp/(1+D^2)$ $Rs=RpD^2/(1+D^2)$
		$D=Rs/2\pi FLs=1/Q$	$Lp=(1+D^2)Ls$ $Rp=(1+D^2)Rs/D^2$
C		$D=1/2\pi FCpRp=1/Q$	$Cs=(1+D^2)Cp$ $Rs=RpD^2/(1+D^2)$
		$D=2\pi FCsRs=1/Q$	$Cp=Cs/(1+D^2)$ $Rp=Rs(1+D^2)/D^2$

$$Q=Xs/Rs, D=Rs/Xs, Xs=1/2\pi FCs=2\pi FLs$$

**Suggestion**

For components with low impedance value  $Z$  (high value capacitors and low value inductors) use the series equivalent circuit,  
For components with large impedance  $Z$  (low value capacitors and high value inductors) use parallel equivalent circuits.  
The equivalent circuit is determined according to the actual use of the component. For example, for a capacitor, a series equivalent circuit is used for power filtering, and a parallel equivalent circuit is used for an LC oscillator circuit.

---

### Test Frequency

---

LCR-1100: 50Hz, 100Hz, 120Hz, 1kHz, 2kHz,  
10kHz, 50kHz and 100kHz

LCR-1010: 50Hz, 100Hz, 120Hz, 1kHz, 2kHz,  
10kHz

Accuracy: 0.02%

---

### Test Level

---

0.3, 0.7 and 1.0 Vrms

Accuracy: 10%

---

### Output Impedance

---

100 $\Omega$

Accuracy: 5%

---

### Range

---

Auto, Hold range. Total 8 Ranges.

---



## Speed

2 speeds: slow and fast.

Test frequency: 1kHz, range: AUTO

Fast: 8 times/s

Slow: 2.3 times/s

Test frequency: 1kHz, range: HOLD

Fast: 10 times/s

Slow: 2.5 times/s

## Basic Accuracy

0.2%

## Display Range

Table 2-2

LCR-1100

Measurement  
Display Range

Function	Display Range
L	0.001 $\mu$ H ~ 999.9H
C	0.001pF ~ 999.9mF
R、X、Z、Rdc	0.0001 $\Omega$ ~ 99.99M $\Omega$
D	0.0001 ~ 9.999
Q	0.0001 ~ 999.9
$\theta$ d	-179.99 $^{\circ}$ ~ 179.99 $^{\circ}$
$\theta$ r	-3.1416 ~ 3.1416
%	-999.9% ~ 999.9%

Table 2-3

LCR-1010

Measurement  
Display Range

Function	Display Range
L	0.01 $\mu$ H ~ 999.9H
C	0.01pF ~ 999.9mF
R、X、Z、Rdc	0.0001 $\Omega$ ~ 99.99M $\Omega$
D	0.0001 ~ 9.999
Q	0.0001 ~ 999.9
$\theta$ d	-179.99 $^{\circ}$ ~ 179.99 $^{\circ}$
$\theta$ r	-3.1416 ~ 3.1416
%	-999.9% ~ 999.9%

## System Settings

---

1. Data hold function.
  2. Measurement parameter settings are automatically saved
  3. Touch screen settings
  4. Power saving mode settings (Automatic power off, APO; Screen dimming time setting, DIM DISPLAY; Screen brightness adjustment, BRIGHTNESS)
- 

## Interface

The instrument supports USB communication interface, which can be set as HID and virtual serial port (VCOM) two interfaces.

---

USB-HID remote control	Support USB high-speed mode 48MHz, ASCII transmission.
------------------------	--

---

USB-VCOM remote control	Virtual serial port communication, baud rate adaptive, maximum baud rate 115200, ASCII transmission.
-------------------------	--

---

## Comparator function

---

The instrument can perform percentage sorting of a group of main parameters, and the secondary parameters do not participate in the sorting.

---

## Connection of test terminal

The instrument has two kinds of test ports: five-terminal and three-terminal test ports.

If you want to meet the accuracy specification of the instrument, you must use the five-terminal test terminal, and the lower accuracy of the three-terminal test will not guarantee the specification.

1. Insert the plug of the test fixture vertically into the five-terminal socket.
2. Move the plug of the test fixture to the right and fix it in the center to avoid poor contact during the test.
3. Removing the test fixture, first move the plug of the fixture to the left, and then pull it out upwards.

Figure  
Connection of test  
terminals

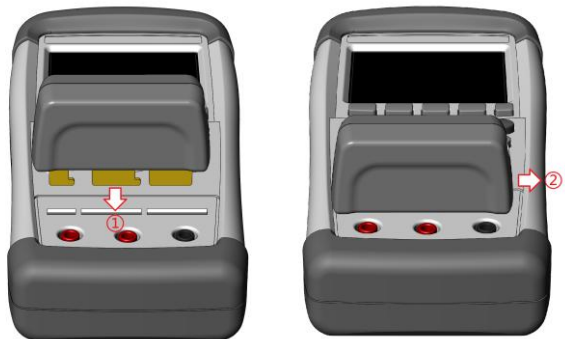

## Battery installation and replacement

The instrument has a built-in rechargeable lithium battery, which has been installed in the battery compartment of the instrument at the factory. If replacing the battery, follow the steps below

---

1. Squeeze the axis of the instrument bracket inward, and remove the bracket.
  2. Use a screwdriver to loosen the 3 screws on the battery cover and remove the battery cover.
  3. Remove the plug on the old battery, plug in the plug of the new battery, pay attention to the direction of the plug.
  4. Put the new battery into the battery compartment, cover the battery cover, and tighten the screws.
  5. Install the instrument bracket.
- 

Figure

Installing and Replacing the Battery



Warning

Please use the original lithium battery (LCR-305) to ensure the safety of the instrument. Using non-original batteries may cause danger to the user or damage the instrument.

---

## Battery and Power supply

Please turn off the instrument for USB charging, and try to avoid using it while charging.

The USB can only charge the battery, cannot supply power for the operation of the instrument.

Use a USB charger that meets CE or UL specifications to charge the instrument to avoid personal injury or instrument damage caused by bad chargers.

When using a USB charger to charge the battery of the instrument, if there is noise from the AC power supply, it may affect the normal measurement of the instrument.

When the instrument uses Type-C to connect to the computer for communication operation, the instrument will only use battery power to maintain the accuracy of the measurement.

- 
1. Battery working no-load current: 8.2V  
166mA 1.4W
  2. Type-C input power supply:  
When starting up/OFF: 5V 2A 10W(charging only)  
Battery continuous working time:  
50% brightness: 9 hours  
100% brightness: 7 hours  
Charging time: Empty to full charge about 2.5 hours
- 

- |                          |   |
|--------------------------|---|
| Power Button light color | <ol style="list-style-type: none"> <li>1. Green (steady light): Power on, normal working status, sufficient power.</li> <li>2. Green (blinking): Power on, low battery.</li> <li>3. Orange: Power on, LCD battery level + lightning, charging. </li> <li>4. Red: Power off, charging.</li> <li>5. Light off: Power off, charging is complete.</li> </ol> |
|--------------------------|---|
-

LCD  
charging/battery  
status display:  
(upper right  
corner)

1. Battery level (white): Sufficient power.
2. Battery level (orange): Low power.
3. Battery level (red): Very low and almost dead.
4. Battery level + lightning (orange): Charging.
5. Battery level + screen: Remote control, not charging. 



Note

Avoid wrong connection, which would lead to incorrect reading value.

In order to ensure the accuracy of the instrument, please use the LCR-1000 optional accessories test cable for test.



Warning

Before connecting the test leads, make sure the test leads are not connected to any component to avoid personal injury or damage to the instrument.

---

# M EASURE

At any time, you can enter the [MEAS DISPLAY] page by pressing the **MEAS** key.

Use the direction key to move the cursor to the setting item, the optional parameters will be displayed at the bottom of the LCD, press the corresponding function key to set.

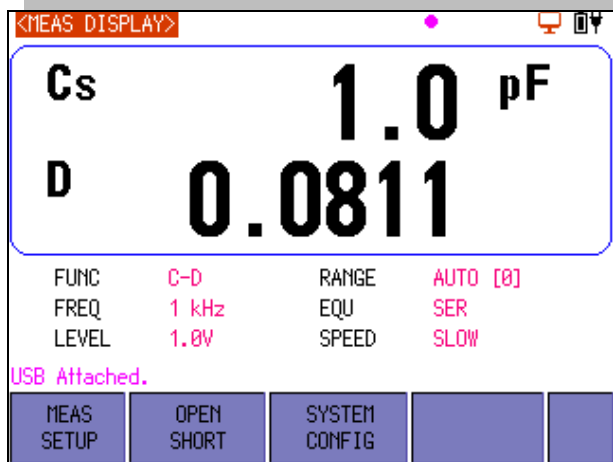

## FUNC

Measurement parameters.

There are 15 measurement function combinations.

C-D, C-Q, C-R, L-D, L-Q, L-R, L-Rdc,R-Q, R-X, R-Rdc, Rdc,  
Z-D, Z-Q, Z- $\theta_r$ , Z- $\theta_d$

Function	L	Inductance
	C	Capacitance
	Rdc	DC Resistance
	R	Resistance
	Z	Impedance
	$\theta_{deg}$	Phase angle of impedance(degree)
	$\theta_{rad}$	Phase angle of impedance(radian)
	Q	Quality Factor, ( $Q = 1/D$ )
	D	Dissipation Factor, Loss coefficient ( $\tan\delta$ )
	X	Reactance

## FREQ

Measurement frequency.

Frequency Accuracy: 0.02%

LCR-1010 : 50Hz, 100Hz, 120Hz, 1kHz, 2kHz, 10kHz

LCR-1100 : 50Hz, 100Hz, 120Hz, 1kHz, 2kHz, 10kHz, 50kHz,  
100kHz



## LEVEL

Measurement signal level.

Level Accuracy: 10%

3 levels: 0.3Vrms, 0.7Vrms, 1.0Vrms

## RANGE

There are 8 ranges, including: 10 $\Omega$ , 100 $\Omega$ , 300 $\Omega$ , 1k $\Omega$ , 3k $\Omega$ , 10k $\Omega$ , 30k $\Omega$ , 100k $\Omega$ .

AUTO	Automatically selects the range. The instrument will select the appropriate range according to the impedance $ Z $ of the device under test.
HOLD	Locks on the current range The fastest test speed.
INCR +	Locks on the current range and increases the range number.
DECL -	Lock on current range and decreases the range number.

Table Range and corresponding test range	Range number	Range definition	Impedance measurement range
	7	10 $\Omega$	0 $\Omega$ ~ 10.5 $\Omega$
	6	100 $\Omega$	10.2 $\Omega$ ~ 320 $\Omega$
	5	300 $\Omega$	300 $\Omega$ ~ 990 $\Omega$
	4	1k $\Omega$	950 $\Omega$ ~ 3.2k $\Omega$
	3	3k $\Omega$	3k $\Omega$ ~ 9.9k $\Omega$
	2	10k $\Omega$	9.5k $\Omega$ ~ 32k $\Omega$
	1	30k $\Omega$	3k $\Omega$ ~ 99k $\Omega$
	0	100k $\Omega$	95k $\Omega$ ~ $\infty$

## **EQU**

Equivalent Circuit methods: Series (SER) and Parallel (PAL).

---

Provide equivalent mode selection for R, L, and C, and obtain the measurement parameters of  $R_s/R_p$ ,  $L_s/L_p$ , and  $C_s/C_p$ .

---

## **SPEED**

Measurement speed: SLOW and FAST

---

Slow: 2.3 times/s (1kHz, AUTO).

Fast: 8 times/s (1kHz, AUTO).

---

# SETUP

At any time, you can enter the [SETUP] page by pressing the **SETUP** key.

Use the direction key to move the cursor to the setting item, the optional parameters will be displayed at the bottom of the LCD, press the corresponding function key to set.

The first six items are the same as the setting items on the [MEAS DISPLAY] page, please refer to the description on the [MEAS DISPLAY] page for details.

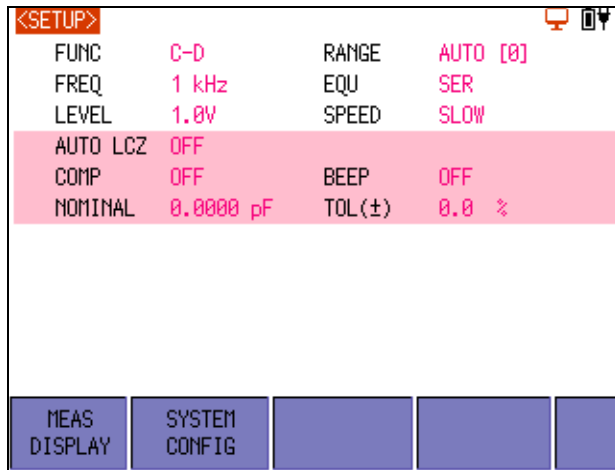

<SETUP>			
FUNC	C-D	RANGE	AUTO [0]
FREQ	1 kHz	EQU	SER
LEVEL	1.0V	SPEED	SLOW
AUTO LCZ	OFF		
COMP	OFF	BEEP	OFF
NOMINAL	0.0000 pF	TOL(±)	0.0 %

MEAS DISPLAY	SYSTEM CONFIG			
-----------------	------------------	--	--	--

## AUTO LCZ

AUTO LCZ function can automatically help to select the best parameters and the best equivalent circuit method.

---

If the range is set to auto, the LCR will be in a fully automatic test state.

After AUTO-LCZ is turned on, the FUNC item will display [AUTO-LCZ] and the EQU item will display [AUTO].

Note: After the automatic parameter is turned on, the user resets [FUNC] or [EQU], and the automatic parameter function will be turned off.

---

## COMP

The built-in simple comparator function of the instrument can compare the main parameters and display the relative deviation percentage on the measurement display page.

---

The formula for the comparator is as follows:

$$Tol = \frac{Rx - Nom}{Nom} \cdot 100\%$$

Rx: current measured value

Nom: Nominal value entered

---

## BEEP

2 kinds of beep functions: qualified and bad beeps, which are used to prompt the test results with beeps.

---

When powered by an external power source, the beep will beep continuously until the status changes.

When on battery power, the beep will beep short until the status changes.

Normally, if you want to enable the beep function, you should set the beep to [Pass].

---

## NOMINAL

If the COMP function is turned on, the nominal value needs to be input before the formula can be calculated.

---

KEYPAD	Input using the touch screen
INPUT	keyboard
MEAS	Use measurement standard
INPUT	component value input

---

**KEYPAD  
INPUT**

After pressing the [KEYPAD INPUT] key, the keyboard input box will be displayed.

Use your finger to lightly touch the number keys on the touch screen to enter the nominal value or use the direction keys to select a number and then press the  key to enter the nominal value.

Figure  
Keyboard  
input box

Finally, press the unit function key to complete the input.

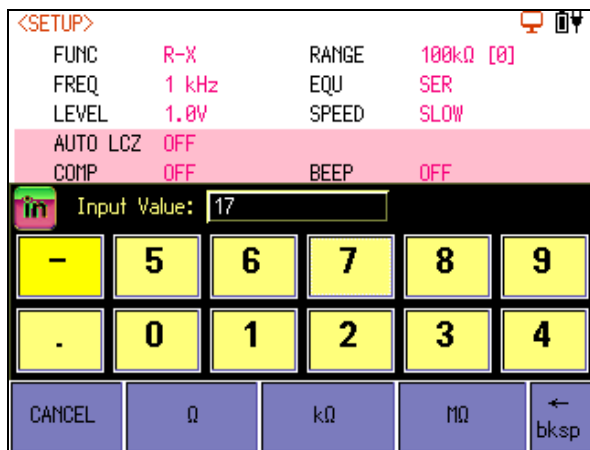

Note: If the touch screen is turned off in the system, when the input box is activated, the touch screen is automatically enabled for touch screen input.

**MEAS  
INPUT**

After pressing the [MEAS INPUT] key, the LCD display prompt:  **Plug a Standard Component...**

After inserting the standard component, press the [OK] key to start measuring the standard component, and the measured value is displayed in the nominal value item.

## TOL( $\pm$ )

If the COMP function is enabled, the calculation result needs to set a percentage threshold to judge PASS or FAIL.

---

Use the touch screen keyboard to enter the relative deviation (percentage deviation), and also provide 4 common values: 1%, 5%, 10% and 20%.

---

# OPEN/SHORT

Prior to measurement, the user needs to correct the fixture to eliminate stray capacitance and series impedance that may be generated by the fixture.

When the instrument is turned on, in order to achieve the accuracy of the technical indicators, please perform open circuit test and short circuit test before measuring after warming up the instrument.

When replacing the test fixture or test cable, please reset the open and short test again.

When the temperature changes greatly, please perform open and short test in time.

---

On the [MEAS DISPLAY] page, press the [OPEN SHORT] key to enter the [OPEN SHORT] page.

This page offers two options:

OPEN TEST - open circuit correction

SHORT TEST - short circuit correction

---

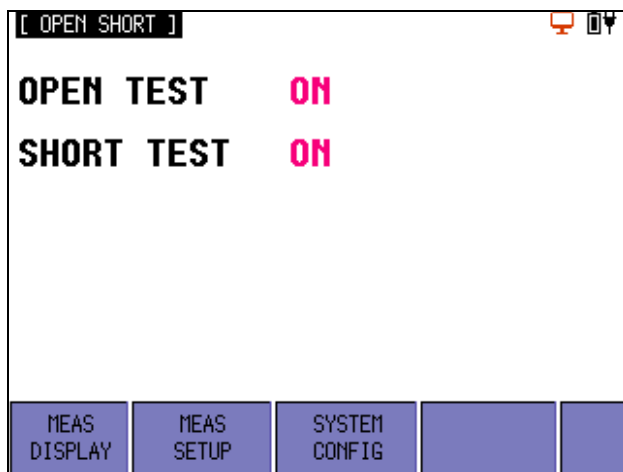



## Open test

Open correction capability cancels errors due to the stray admittance( $G,B$ ) in the test fixture.

Figure  
Stray admittance

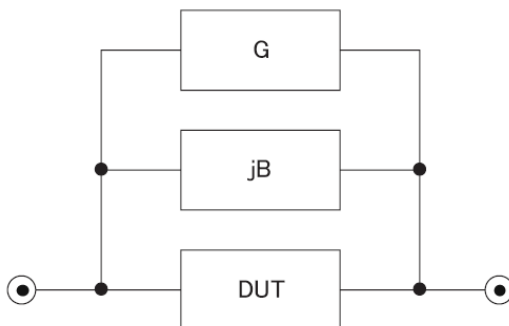

Function	ON/OFF	Enable or Disable the open circuit correction function.
	MEAS OPEN	Open correction for LCR only.
	DCR OPEN	Open correction for DCR only.

- Steps
1. Press the [OPEN SHORT] key to enter the [OPEN SHORT] page.
  2. Use the arrow keys to select the [OPEN TEST] item.
  3. Select [MEAS OPEN] or [DCR OPEN] to start open correction.  
 LCD display prompt: **Open-circuit the test terminals**  
 At this time, please keep the test terminal or test fixture open and do not contact with any objects.

4. Press [OK] to start correction.  
During correction, the LCD will display a progress bar, and you can press the [CANCEL] key to cancel the correction.
5. After the correction is completed, the LCD will prompt: **LCR/DCR correction finished**.  
If the correction fails, the LCD will prompt: **LCR/DCR correction fail!** Please check if there is any error?

Open Circuit

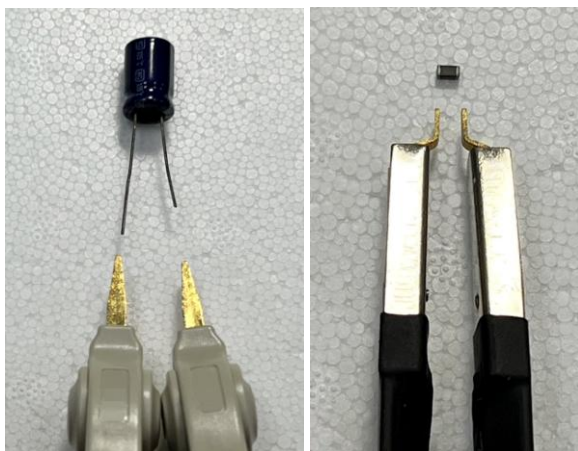

- If the H/L test pole of the test fixture can be adjusted, adjust the distance between the test poles to the distance when measuring.

## Short test

Short correction compensates for any residual impedances ( $R, X$ ), such as the impedance of the cables and the DUT connection points.

Figure  
Residual  
impedances

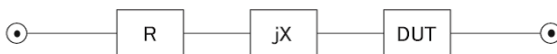

ON/OFF      Enable or Disable the short circuit correction function.

MEAS SHORT    Short correction for LCR only.

DCR SHORT    Short correction for DCR only.

### Steps

1. Press the [OPEN SHORT] key to enter the [OPEN SHORT] page.
2. Use the arrow keys to select the [SHORT TEST] item.
3. Select [MEAS SHORT] or [DCR SHORT] to start short correction.

LCD display prompt:  **Short-circuit the test terminals**

Please insert the short bar into the test terminal or short the test fixtures together.

4. Press [OK] to start correction.  
During correction, the LCD will display a progress bar, and you can press the [CANCEL] key to cancel the correction.
5. After the correction is completed, the LCD will prompt: **LCR/DCR correction finished.** If the correction fails, the LCD will prompt: **LCR/DCR correction fail!** Please check if there is any error?

---

### Short Circuit



# S SYSTEM CONFIG

At any time, you can enter the [SYSTEM CONFIG] page by pressing the **SYST** key.

Use the direction key to move the cursor to the setting item, the optional parameters will be displayed at the bottom of the LCD, press the corresponding function key to set.

All settings of the system configuration are automatically saved when the system is turned off.

This page offers two options:

**SYSTEM INFO** - Displays the model, serial number and firmware/hardware version of the instrument. This page has no user configurable options.

**SYSTEM SERVICE** - Engineering mode, which user is not allowed to operate.

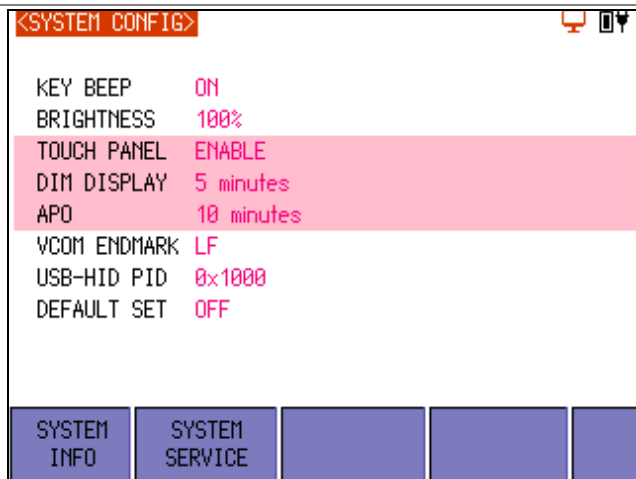

## KEY BEEP

Turn ON or OFF key and touch screen sounds.

---

## BRIGHTNESS

The instrument has two sections of LCD screen brightness for adjustment: 50%, 100%

---

When powered by external power supply, the screen brightness will be automatically adjusted to 100%

When the battery is powered, if you want to extend the working time, you can use 50% brightness to reduce the power consumption of the instrument.

It can be directly adjusted by keyboard key [  ]

Figure  
Brightness  
adjustment keys

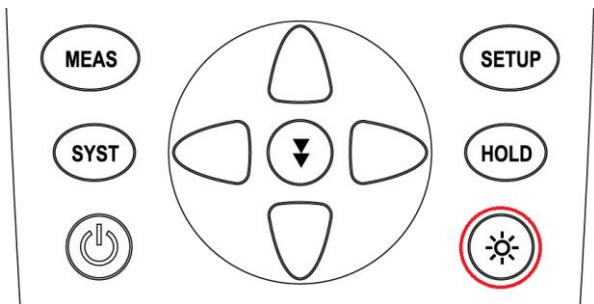

## TOUCH PANEL

The instrument can complete the measurement operation by using the direction building and function keys.

However, when a value needs to be input, a touch screen is required to assist input.

When the input box is opened, if the touch screen is closed, it will be automatically opened for use.

---

Available parameter	ENABLE	Turn on the touch screen function
	DISABLE	Turn off the touch screen function
	CALIBRATE	Calibrate touch screen coordinates
	RESET	Resets the coordinates of the touch screen to the factory value of the instrument.

---

**Touch screen calibration steps**

1. Touch screen calibration requires a touch pen, which can be calibrated with a mobile phone/tablet touch pen.

It is not recommended to use fingers to calibrate the touch screen, because the finger contact point is large and inaccurate.

Press the **CALIBRATE** function key to enter the calibration page. Use the touch pen to touch the screen, and the calibration starts.



2. Calibrate the first point: touch the cross in the upper left corner.

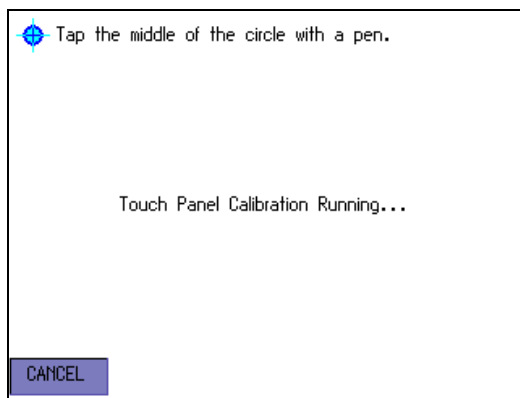



3. Calibrate the second point: touch the cross in the lower right corner.

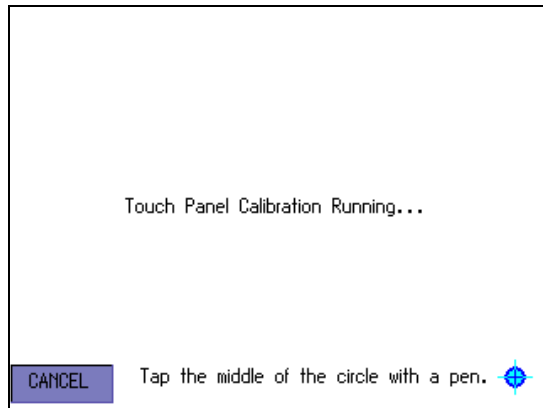

4. Calibration complete. Tap the screen to exit the calibration process.

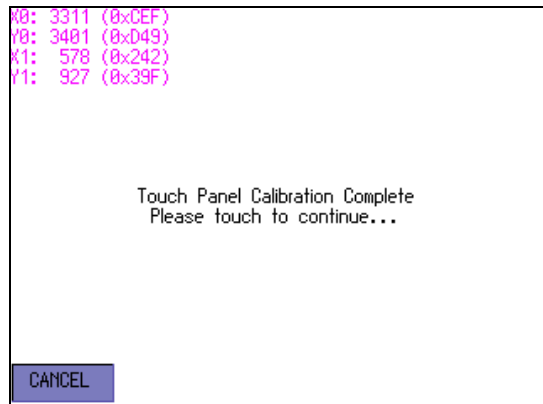

## **DIM DISPLAY**

Decrease backlight brightness time setting.

---

When the instrument is powered by batteries, it can be set that no button and touch screen operations are performed within a specified period of time, and the screen backlight can be actively reduced to save battery power.

Setting time options: 5 /10 /20 /30 minutes.

NOTE: This feature is only available on battery power.

---

## **APO**

Auto Power Off Time Setting.

---

When the instrument is powered by battery, it can set the time for automatic shutdown without any operation.

Setting time options: 5 /10 /20 /30 minutes.

NOTE: This feature is only available on battery power.

---

## VCOM ENDMARK

USB virtual serial port terminator.

---

LCR-1000 series has a built-in USB-VCOM virtual serial port for communication with the host computer. USB-VCOM supports the following configurations:

- Data bits: 8 bits
- Stop bit: Adaptive, 1 or 2 bits
- Parity: None
- Baud rate: adaptive, up to 115200bps.

The LCR-1000 communication protocol uses a simple SCPI protocol, which only supports single-line instructions and does not support instruction cascading.

1. The end character must be added at the end of the command sent by the host computer, and the instrument will respond.
2. The end character sent by the host computer must be one of them: NUL (0x00), LF (0x0A), CR (0x0D), CR+LF (0x0D0A), which may not be the same as the VCOM ENDMARK setting.
3. The setting of VCOM ENDMARK will be added at the end of the data returned by the instrument.

Available parameter	NUL	HEX 0x00
	LF	HEX 0x0A
	CR	HEX 0x0D
	CR+LF	HEX 0x0D0A

## USB-HID PID

Instrument ID setting.

---

LCR-1000 series has a built-in standard USB-HID communication interface for high-speed communication with the host computer.

By setting the PID of USB-HID, the host computer can establish communication with up to 8 LCR-1000s.

Before multi-machine communication, be sure to set the PID of each instrument to a different PID.

Available parameter	1000	HEX 0x1000
	1001	HEX 0x1001
	1002	HEX 0x1002
	1003	HEX 0x1003
	1004	HEX 0x1004
	1005	HEX 0x1005
	1006	HEX 0x1006
	1007	HEX 0x1007

## DEFAULT SET

Reset settings to factory defaults.

---

The factory settings are as follows:

SETUP	SYSTEM
FUNC: C-D	KEY BEEP: ON
FREQ: 1kHz	TOUCH PANEL: DISABLE
LEVEL: 1.0V	DIM DISPLAY: 5 minutes
RANGE: AUTO	APO: 10 minutes
EQU: SER	VCOM ENDMARK: LF
SPEED: SLOW	USB-HID PID: 1000
AUTO LCZ: OFF	
COMP: OFF	
BEEP: OFF	
NOMINAL: 0.0000pF	
TOL(±): 0.0%	

## SYSTEM INFORMATION

Displays the model, serial number , firmware/hardware/USB version and USB VID/PID of the instrument.

This page has no user configurable options.

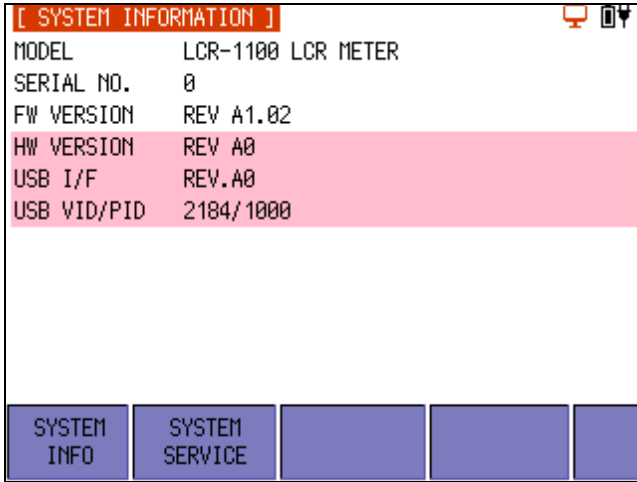

# M EASUREMENT

## EXAMPLES

To measure a thin film ceramic capacitor, explain how to measure the capacitance value.

---

Before testing, please determine the following measurement conditions according to the specifications of the capacitor.

- DUT: film capacitor
  - Test fixture: If the capacitor can be directly inserted into the test terminal of the instrument, there is no need to connect another fixture. If it cannot be used, please choose a test fixture suitable for the capacitor (Kelvin clip or SMD clip).
  - Main parameter: Capacitance (C)
  - Secondary parameter: Loss (D)
  - Test frequency: 1kHz
  - Test level: 1V
- 

- |       |   |
|-------|---|
| Steps | <ol style="list-style-type: none"><li>1. Press the power button to start the instrument, the instrument will enter the &lt;MEAS DISPLAY&gt; page.</li><li>2. Use the arrow keys to move the cursor and select the setting condition. Warm up for 30 minutes.<br/>[FUNC]: C-D                    [RANGE]: AUTO<br/>[FREQ]: 1kHz                 [EQU]: SER<br/>[LEVEL]: 1.0V                [SPEED]: SLOW</li><li>3. Please install the test fixture or use the test slot of the instrument.</li></ol> |
|-------|---|
-

4. Please follow the OPEN/SHORT chapter to perform open circuit and short circuit zero reset calibration.
5. Insert the capacitor into the test slot of the instrument or connect the capacitor with a test fixture.
6. Read the test result.

Figure  
Test results for  
capacitors



**Note**

- Do not apply DC voltage or current to the test terminal, otherwise the instrument will be damaged.
- Before testing the capacitor, make sure the capacitor has been discharged, otherwise the voltage will damage the instrument.
- Do not use in humid environment or dusty environment.



# RREMOTE CONTROL

LCR-1000 has a USB Type-C interface, which provides a virtual serial port (VCOM) or USB-HID class to connect and control with a computer.

## Connect to PC to ensure measurement accuracy

---

LCR-1000 needs to be connected to PC for command control measurement. In order to ensure the measurement accuracy, the instrument will not use an external power supply, but will only use the internal battery for measurement.

Connect the PC to the USB port of the instrument, "USB Attached. (Not Charging)" will be displayed at the bottom of the LCD screen of the instrument, indicating that the battery is not charged, and the PC will not supply power to the instrument. At this time, the instrument is completely powered by batteries to ensure measurement accuracy. Only the connection symbol and battery symbol are displayed on the upper right of the LCD. 

Before using the PC connection to control the measurement, please fully charge the battery for convenience.

---

## USB-VCOM virtual serial port

---

LCR-1000 connected to PC, it will automatically install the driver and create a virtual serial port.

The serial port number needs to be viewed in the Device Manager

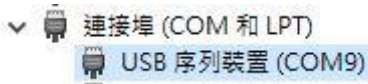

(Device Manger):

USB-VCOM follows the standard serial protocol for communication.

USB-VCOM communicates using the following parameters:

1. Data bits: 8 bits
2. Stop bit: adaptive, 1 or 2 bits
3. Parity: None
4. Baud rate: adaptive, up to 115200bps.

When using USB-VCOM to communicate with LCR-1000, please use the simplified SCPI protocol, which can only send one command at a time, and cannot use multiple commands.

For example:

Correct: SEND> FUNC C-D <terminator>

Error: SEND> FUNC C-D;FREQ 1K<terminator>



Note

The USB-VCOM of the instrument is always on, and there is no need to set any additional parameters.

---

## USB-HID device class

---

LCR-1000 provides USB-HID class, which can be automatically identified by Windows when connected to a PC.

Therefore, the user does not need to install the driver, and the instrument can be installed automatically under the Windows system (as shown below), and the user can use the Windows internal API function to complete the control of the instrument.

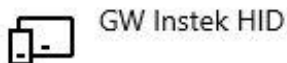

The instrument provides free data communication examples for user reference, and the example codes are issued together with the manual.

Communication parameters:

- VIP: 2184 (HEX)
- PID: 1000~1007 (HEX)
- Packet: 64 bytes

The basic API functions used are as follows:

- CreateFile(  
    devDetail->DevicePath, // Device path  
    GENERIC\_READ | GENERIC\_WRITE, // Access method  
    FILE\_SHARE\_READ | FILE\_SHARE\_WRITE, // Share mode  
    NULL,  
    OPEN\_EXISTING, // When the file does not exist, return failure  
    FILE\_FLAG\_OVERLAPPED, // Open in overlapped (asynchronous) mode  
    NULL);

Here, CreateFile is used to open the HID device, where the device path is obtained through the function SetupDiGetInterfaceDeviceDetail.

- ReadFile(

```
hDev, // Device handle, which is the return value of
      CreateFile
rcvBuffer, // Buffer for receiving data
IN_REPORT_LEN, // The length of the data to be read
&rcvBytes, // The number of bytes of data actually
           received
&ol); // Asynchronous mode
```

Here, ReadFile is used to read the input report sent by the HID device through the interrupt IN transfer.

- WriteFile(

```
hDev, // Device handle, which is the return value of
      CreateFile
reportBuf, // Buffer with data to be sent
OUT_REPORT_LEN, // Length of data to be sent
&sendBytes, // The number of bytes of data actually
           received
&ol); // Asynchronous mode
```

Here, WriteFile is used to transmit an output report to the HID device.



Note

- LCR-1000 only supports operating systems above Windows7.
  - If user needs to write software by himself, please understand the related knowledge of USB and USB-HID first, which can be obtained from [www.usb.org](http://www.usb.org) website.
-

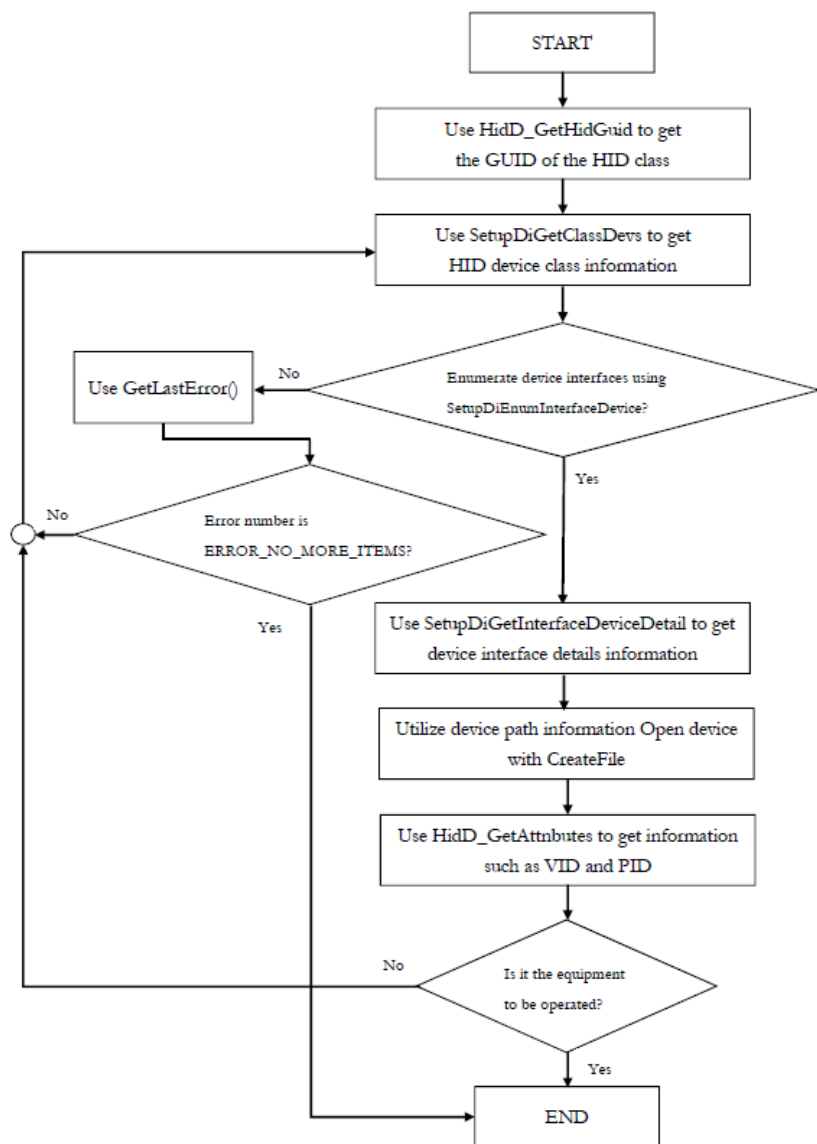

# C COMMAND OVERVIEW

The LCR-1000 instruction set is common to both USB-HID and USB-VCOM. The difference is that USB-HID needs to be packaged and used, while USB-VCOM can be used directly.

## USB-HID command package

The command packet format sent by the PC (a packet structure defined in C language, other language formats must be similar):

```
#define program pack(1)
typedef __packed struct
{
    uint    cSize;           //Packet size 4 =60
    char    sHeader[24];    //Command 24
    char    sPara[28];      //Parameter 28
    uint    nSignature;     //Signature 4 =0x88805550
    uint    nChecksum;     //Checksum 4
} TUSB_CMD;
#define program pack()

in,
cSize:           always 60
nSignature:     always 0x88805550
sCmd and sPara: see SCPI command set
nChecksum:     32-bit checksum
```

A complete sending instruction package (PC side) is as follows:

cSize: 0x0000003C,  
 sHeader: IDN?  
 sPara: (empty)  
 nSignature: 0x88805550  
 nChecksum: 0x00002BC1

Since the format and number of digits of the sending command packet are fixed, the command word and parameters must be filled with hexadecimal HEX: 0x00 if the number of bytes is less than the specified number. For example, the Hex format of a complete sending packet is as follows:

Table A command to send packet data	0	1	2	3	4	5	6	7	8	9	10	11	12	13	14	15
	00	00	00	40	49	44	4E	3F	00	00	00	00	00	00	00	00
	16	17	18	19	20	21	22	23	24	25	26	27	28	29	30	31
	00	00	00	00	00	00	00	00	00	00	00	00	00	00	00	00
	32	33	34	35	36	37	38	39	40	41	42	43	44	45	46	47
	00	00	00	00	00	00	00	00	00	00	00	00	00	00	00	00
	48	49	50	51	52	53	54	55	56	57	58	59	60	61	62	63
	00	00	00	00	00	00	00	00	88	80	55	50	00	00	2B	C1

The packet size of the instrument response is also 64 bytes, which is not enough to fill with 0x00 (Note: not the ASCII number 0).

A received packet (instrument side) is as follows:  
 ASCII format: GwINSTEK,LCR-1100,0,REV A1.0

## Specifiers

When describing the directive, we use some specifiers, these specifiers are not part of the directive, just for the convenience of explanation, please don't include it when passing the directive.

Table	Specifier	Description
Specifiers	< >	Angle brackets denote parameter names
	[ ]	Square brackets indicate that the content is optional
		Indicates multiple choice

## Data types

LCR-1000 supports multiple data types

Table	Format	Description	Example
List of data formats	<NR1>	Integer	100, +100, -100
	<NR2>	Real number	1.23, +1.23, -1.23
	<NR3>	floating point number	1.23E4, +1.23E4, -1.23E4, -1.23e-4
	<NR4>	Floating point number with multiplier	1.23K, 1.23N, 1.23U (see the table below for multiplier)

Table	Definition	Suffix
Magnification	1E18 (EXA)	EX
	1E15 (PETA)	PE
	1E12 (TERA)	T
	1E9 (GIGA)	G
	1E6 (MEGA)	MA
	1E3 (KILO)	K
	1E-3 (MILLI)	M
	1E-6 (MICRO)	U
	1E-9 (NANO)	N
	1E-12 (PICO)	P
	1E-15 (PEMTO)	F
1E-18 (ATTO)	A	



## Command List

### Summary of all USB commands

Command (sHeader)	Parameter (sPara)	Description
DISP:PAGE	MEAS SETUP SYSTEM CSET SINF	Switch display page
DISP:PAGE?		Query the name of the currently displayed page
DISP:LINE	String (maximum 28 characters)	Display the string in the bottom prompt bar
FUNC	C-D C-Q C-R L-D  L-Q L-R L-Rdc  R-Q R-X R-dc Rdc Z-D Z-Q Z-thr Z-thd	Set the measurement function
FUNC?		Query main parameter options
FUNC:EQU	SERIAL PARALLEL AUTO	Set the equivalent mode option
FUNC:EQU?		Query equivalent mode options
FUNC:LCR:RANG	0~7	Set LCR range
FUNC:LCR:RANG?		Query the LCR range number
FUNC:DLCR:RANG	0~7	Set DCR range
FUNC:DCR:RANG?		Query the DCR range number
FUNC:RANG:AUTO	ON OFF 1 0	Set the range automatically
FUNC:RANG:AUTO?		Query the automatic state of the range
FREQ	50 100 120 1k 2k 10k 50k 100k	set the frequency value
FREQ?		query frequency value
APER	SLOW   FAST	Set test speed
APER?		Query test speed
FETC?		Query test results
COMP	ON   OFF   1   0	Turn on/off the comparator
COMP:BEEP	OFF   PASS   FAIL	Turns the beep on/off
COMP:NOM	<float number>	Enter nominal value
COMP:NOM?		Query the nominal value
COMP:TOL	<float number>	Enter a percentage value
COMP:TOL?		Query percentage value

CORR:OPEN:STAT	ON OFF 1 0	Open circuit reset switch
CORR:OPEN:STAT?		Query the open circuit reset switch
CORR:SHOR:STAT	ON OFF 1 0	short circuit reset switch
CORR:SHOR:STAT?		Query the short circuit reset switch
CORR:OPEN:LCR		Execute LCR open circuit clear
CORR:SHOR:LCR		Execute LCR short circuit clear
CORR:OPEN:DCR		Execute DCR open circuit clear
CORR:SHOR:DCR		Execute DCR short circuit clear
SYST:KEYL	ON OFF 1 0	key lock switch
IDN?		Query version number
RST		Performs a warm boot
ERR?		Query error code and information

## Commands

---

DISP:PAGE <meas|setup|system>  
DISP:PAGE?

---

Function : It sets or queries the display page.

---

Description :

Set parameter <MEAS|SETUP|SYSTEM|CSET|SINF>

Set syntax DISP:PAGE

Query syntax DISP:PAGE?

Return data <meas|setup|cset|sinf|system>

---

- Note
- MEAS: Measurement display page
  - SETUP: Setup page
  - SYSTEM: System page
  - CSET: OPEN/SHORT calibration page
  - SINF: System Information page
- 

DISP:LINE <string>

---

Function : It displays the specified character string in the help prompt column of the instrument.

---

Description :

Set parameter <string> The content of the string to be displayed, the maximum length of the string is 28 bytes, if the length exceeds, it will be ignored.

Set syntax DISP:LINE

---

FUNC <C-D, C-Q, C-R, L-D, L-Q, L-R, L-Rdc, R-Q, R-X, R-Rdc,  
Rdc, Z-D, Z-Q, Z- $\theta$ r, Z- $\theta$ d>  
FUNC?

---

Function : It sets or queries the measurement parameters.

Description :

Set parameter <C-D|C-Q|C-R|L-D|L-Q|L-R|L-Rdc|R-Q| R-X|R-  
Rdc|Rdc|Z-D|Z-Q|Z-thr|Z-thd>

Set syntax FUNC

Query syntax FUNC?

Return data <C-D|C-Q|C-R|L-D|L-Q|L-R|L-Rdc|R-Q|R-X| R-  
Rdc|Rdc|Z-D|Z-Q|Z-thr|Z-thd>

- 
- Note
- When AUTO-LCZ is ON, after sending FUNC command, AUTO-LCZ will be turned off.

FUNC:EQU <SERIAL|PARALLEL>  
FUNC:EQU?

---

Function : It sets or queries the equivalent mode.

Description :

Set parameter <SERIAL|PARALLEL>

Set syntax FUNC:EQU

Query syntax FUNC:EQU?

Return data <SERIAL|PARALLEL>

- 
- Note
- When AUTO-LCZ is ON, after sending FUNC:EQU command, AUTO-LCZ will be turned off.

FUNC:LCR:RANG <0|1|2|3|4|5|6|7>  
FUNC:LCR:RANG?

---

Function : It sets or queries the LCR measurement range.

---

Description :

Set parameter <0|1|2|3|4|5|6|7> 0~7 represents the range number

Set syntax FUNC:LCR:RANG

Query syntax FUNC:LCR:RANG?

Return data <0|1|2|3|4|5|6|7>

---

FUNC:DCR:RANG <0|1|2|3|4|5|6|7>  
FUNC:DCR:RANG?

---

Function : It sets or queries the DCR measurement range.

---

Description :

Set parameter <0|1|2|3|4|5|6|7> 0~7 represents the range number

Set syntax FUNC:DCR:RANG

Query syntax FUNC:DCR:RANG?

Return data <0|1|2|3|4|5|6|7>

---

FUNC:RANG:AUTO <ON|OFF|1|0>  
FUNC:RANG:AUTO?

---

Function : It sets or queries the range mode.

---

Description :

Set parameter <ON|OFF|1|0>

Set syntax FUNC:RANG:AUTO

Query syntax FUNC:RANG:AUTO?

Return data <ON|OFF|1|0>

---

FREQ <50|100|120|1k|2k|10k|50k|100k>  
FREQ?

Function : It sets or queries the test frequency.

Description :

Set parameter <50|100|120|1k|2k|10k|50k|100k>

Set syntax FREQ

Query syntax FREQ?

Return data <50|100|120|1000|2000|10000|50000| 100000>

- Note
- The frequency value can accept any numerical format, but the data must be the frequency value of the instrument, and the incorrect frequency value will use the closest correct frequency value.
  - The frequency values for each model are as follows:  
LCR-1010: 50 | 100 | 120 | 1k | 2k | 10k  
LCR-1100:  
50 | 100 | 120 | 1k | 2k | 10k | 50k | 100k

APER <SLOW|FAST>  
APER?

Function : It sets or queries the test speed.

Description :

Set parameter <SLOW|FAST>

Set syntax APER

Query syntax APER?

Return data <SLOW|FAST>

FETC?

Function : It queries the test results.

Description :

Query syntax FETC?

Return data <primary parameter result, secondary parameter

---



---

result>

---

Note

- The instrument returns the test results of the primary and secondary parameters NR3 type. If the secondary parameter is closed, it will return data +0.000000e+00
  - Example: +7.929158e-15,+0.000000e+00
- 

COMP <ON | OFF | 0 | 1>  
COMP?

---

Function : It sets or queries the status of the comparator.

---

Description :

Set parameter &lt;ON | OFF | 0 | 1&gt;

Set syntax COMP

Query syntax COMP?

Return data &lt;on|off&gt;

COMP:BEEP <OFF | PASS | FAIL>  
COMP:BEEP?

---

Function : It sets or queries the status of the beep.

---

Description :

Set parameter &lt;OFF | PASS | FAIL&gt;

Set syntax COMP:BEEP

Query syntax COMP:BEEP?

Return data &lt;OFF | PASS | FAIL&gt;

COMP:NOM <NR1|NR2|NR3|NR4>  
COMP:NOM?

---

Function : It inputs and queries the data of nominal value.

---

Description :

Set parameter &lt;NR1|NR2|NR3|NR4&gt; any form of data

Set syntax COMP:NOM

Query syntax COMP:NOM?

Return data &lt;NR3&gt; Example: 1.000000e-09

COMP:TOL <NR1|NR2|NR3>  
COMP:TOL?

---

Function : It inputs and queries the percentage deviation.

---

Description :

Set parameter <NR1|NR2|NR3> any form of data, the input data is percentage data (no need to divide by 100), Do not enter the percent sign %, Example: COMP:NOM 2 //Indicates 2%

Set syntax COMP:TOL

Query syntax COMP:TOL?

Return data <NR2> Example: 10.0

---

CORR:OPEN:STAT <ON|OFF|1|0>  
CORR:OPEN:STAT?

---

Function : It sets and queries the status of the open circuit correction function.

---

Description :

Set parameter <ON|OFF|1|0>

Set syntax CORR:OPEN:STAT

Query syntax CORR:OPEN:STAT?

Return data <on|off>

---

CORR:SHORT:STAT <ON|OFF|1|0>  
CORR:SHORT:STAT?

---

Function : It sets and queries the status of the short circuit correction function.

---

Description :

Set parameter <ON|OFF|1|0>

Set syntax CORR:SHORT:STAT

Query syntax CORR:SHORT:STAT?

Return data <on|off>

---



---

### CORR:OPEN:LCR

---

Function : It executes LCR open circuit correction.

---

Description :

Set syntax CORR:OPEN:LCR

Return data <pass|fail>

---

- Note
- “LCR open” is prompted when the correction starts
  - Prompt “pass or fail” after correction
- 

---

### CORR:SHORT:LCR

---

Function : It executes LCR short circuit correction.

---

Description :

Set syntax CORR:SHORT:LCR

Return data <pass|fail>

---

- Note
- “LCR short” is prompted when the correction starts
  - Prompt “pass or fail” after correction
- 

---

### CORR:OPEN:DCR

---

Function : It executes DCR open circuit correction.

---

Description :

Set syntax CORR:OPEN:DCR

Return data <pass|fail>

---

- Note
- “DCR open” is prompted when the correction starts
  - Prompt “pass or fail” after correction
-

---

### CORR:SHORT:DCR

---

Function : It executes DCR short circuit correction.

---

Description :

Set syntax CORR:SHORT:DCR

Return data <pass|fail>

---

- Note
- "DCR short" is prompted when the correction starts
  - Prompt "pass or fail" after correction
- 

---

### SYST:KEYL <ON | OFF | 1 | 0>

---

Function : It locks or unlocks the keypad and touch screen.

---

Description :

Set parameter <ON | OFF | 1 | 0>

Set syntax SYST:KEYL

---

- Note
- When the keys and touch screen are locked, the user can press the LOCAL [  ] key to unlock!
  - The power button and key tone still work.
- 

---

### SYST:HOLD <ON | OFF | 1 | 0>

---

Function : It holds or releases the current screen data.

---

Description :

Set parameter <ON | OFF | 1 | 0>

Set syntax SYST:HOLD

---

- Note
- When the measured value is held, a red symbol **DH** will be displayed on the upper right corner of the screen.
  - This command is valid only on the "MEAS DISPLAY" page.
-

## IDN?

---

Function : It is used to query the manufacturer, model, serial number and version information of the instrument.

---

Description :

Query syntax IDN?

Return data manufacturer, model, serial number,version

Example: GwINSTEK,LCR-1100,<SN>,REV A1.03

---

## ERR?

---

Function : It queries whether the command sent before is wrong?

---

Description :

Query syntax ERR?

Return data Error message

---

Error codes and messages		Error message
	0	No error
	1	Bad command
	2	Parameter error
	3	Missing parameter
	4	Invalid multiplier
	5	Numeric data error
	6	Value too long
	7	Invalid command
		No error
		command error
		Parameter error
		Missing parameter
		Multiplier error
		Numerical data error
		The value is too long
		Invalid command, indicating that the command is invalid in the current state

---

# SPECIFICATIONS

## Specifications

If the following conditions are met during the measurement, the measurement result can reach the basic accuracy.

Warranted performance. All specification apply at  $23 \pm 5$  °C, unless otherwise stated, and 30 minutes after the instrument has been turned on.

- Calibration: Yearly
- Reset adjustment: Perform correction before testing
- the test port of the instrument itself
- Test cable length: 0m
- Open and short calibration has been performed
- When using the external power, the accuracy is unspecified.

## General Characteristics

### Specification Conditions:

Temperature: 18°C~28°C

Humidity:  $\leq 70\%$  RH(non-condensing)

### Operating Environment

Temperature Range: 0~40°C

Relative Humidity:  $\leq 80\%$  RH(non-condensing)

### Storage Conditions

Temperature Range: -10~70°C

Relative Humidity:  $\leq 90\%$  RH(non-condensing)

### Power

Power: Rechargeable lithium battery(8.4V)

Instrument operating power: 1.5W

Battery continuous working time: 7 hours(100% backlight), 9 hours(50% backlight)

Battery charging power: 5VDC, 2A, 10W(maximum)

Battery charging time: within about 3 hours

USB charger output: 5VDC, 2A(minimum)

PC USB port output: 5VDC, 2A(minimum)

#### General

Dimensions: 90 mm (W) X 195 mm (H) X 41 mm (D)

Weight: Approximately 380g (battery included)

#### Safety and EMC

EN55011,EN61326,EN61000

Display	2.8" LCD color display with touch screen
Backlight	50% 、 100%
Dim display brightness	5 minutes/10 minutes/20 minutes/30 minutes/off *Only works on battery power
Auto power off	5 minutes/10 minutes/20 minutes/30 minutes/off *Only works on battery power
Function	C-D, C-Q, C-R, L-D, L-Q, L-R, L-Rdc, R-Q, R-X, R-Rdc, Rdc, Z-D, Z-Q, Z- $\theta$ r, Z- $\theta$ d
Counts	5000 counts
Basic accuracy	0.2%
Equivalent	Series 、 Parallel
Range	Auto range 、 Hold range
Speed	Slow 2.5 times/sec 、 Fast 10 times/sec
Level	0.3V, 0.7V and 1.0Vrms, Accuracy: 10%
Frequency	LCR-1010: 50Hz, 100Hz, 120Hz, 1kHz, 2kHz, 10kHz LCR-1100: 50Hz, 100Hz, 120Hz, 1kHz, 2kHz, 10kHz, 50kHz , 100kHz Accuracy: 0.02%
Output Impedance(RO)	100 $\Omega$ , Accuracy: 5%
Correction	Open 、 Short
Comparator	Main parameter(%), support sound(Pass/Fail)
Test terminal	5-terminal and 3-terminal
Interface	USB(Type C) Device class(HID),Virtual serial port(VCOM)

## Accuracy

---

The following accuracy guarantees can only be provided by using a five-wire terminal test socket or a connection test fixture for measurement.

Measurements are made using 3-wire terminal sockets for quick measurement reference only.

## Test Cable

---

Use the five-wire terminal test socket to measure directly, and the accuracy error is only shown in the table.

If the Kelvin Clip or Tweezers test fixture is connected for measurement, the length accuracy error of the test line must be added.

**Accuracy:**  $\pm(A \times B)(\% \text{ of reading})$

A: Basic accuracy specified in the table

B: Test Cable Accuracy

$$B = 1 + (L \times F)$$

L: Test cable length factor, "L" is 0.05

F: Test frequency (kHz)

## Accuracy C and D

## ■ 50Hz/60Hz/100Hz/120Hz

Range	Display range	Accuracy Ce	Accuracy De
20mF	5.0000mF - 50.000mF	2.0%+5 counts	0.0200
5mF	500.0 $\mu$ F - 4.9999mF	1.0%+3 counts	0.0100
500 $\mu$ F	50.00 $\mu$ F - 499.99 $\mu$ F	0.5%+2 counts	0.0050
50 $\mu$ F	5.000 $\mu$ F - 49.999 $\mu$ F	0.35%+2 counts	0.0020
5 $\mu$ F	500.0nF - 4.9999 $\mu$ F	0.2%+2 counts	0.0020
500nF	50.00nF - 499.99nF	0.2%+2 counts	0.0020
50nF	5.000nF - 49.999nF	0.6%+3 counts	0.0030
5nF	500pF - 4.9999nF	2.0%+5 counts	

## ■ 1kHz/2kHz

Range	Display range	Accuracy Ce	Accuracy De
1mF	500.0 $\mu$ F - 4.9999mF	1.0%+5 counts	0.0500
500 $\mu$ F	50.00 $\mu$ F - 499.99 $\mu$ F	0.3%+3 counts	0.0300
50 $\mu$ F	5.000 $\mu$ F - 49.999 $\mu$ F	0.2%+2 counts	0.0030
5 $\mu$ F	500.0nF - 4.9999 $\mu$ F	0.2%+2 counts	0.0020
500nF	50.00nF - 499.99nF	0.2%+2 counts	0.0020
50nF	5.000nF - 49.999nF	0.2%+2 counts	0.0020
5nF	500.0pF - 4.9999nF	0.3%+3 counts	0.0030
500pF	50.0pF - 499.9pF	0.65%+5 counts	

## ■ 10kHz

Range	Display range	Accuracy Ce	Accuracy De
50 $\mu$ F	5.000 $\mu$ F - 49.999 $\mu$ F	1.0%+3 counts	0.0100
5 $\mu$ F	500.0nF - 4.9999 $\mu$ F	0.3%+2 counts	0.0030
500nF	50.00nF - 499.99nF	0.2%+2 counts	0.0020
50nF	5.000nF - 49.999nF	0.2%+2 counts	0.0020
5nF	500.0pF - 4.9999nF	0.2%+2 counts	0.0020
500pF	50.0pF - 499.9pF	0.3%+3 counts	0.0030
50pF	5.00pF - 49.99pF	1.2%+5 counts	

## ■ 50kHz/100kHz

Range	Display range	Accuracy Ce	Accuracy De
5 $\mu$ F	500.0nF - 4.9999 $\mu$ F	3.0%+10 counts	0.0300
500nF	50.00nF - 499.99nF	0.3%+5 counts	0.0030
50nF	5.000nF - 49.999nF	0.2%+2 counts	0.0020
5nF	500.0pF - 4.9999nF	0.2%+2 counts	0.0020
500pF	50.00pF - 499.99pF	0.3%+2 counts	0.0020
50pF	5.000pF - 49.999pF	1.0%+5 counts	0.0100
5pF	1.000pF - 4.999pF	3%+10 counts	

## Accuracy L and Q

■ **50Hz/60Hz/100Hz/120Hz**

Range	Display range	Accuracy Le	Accuracy Qe
1000H	500.0H – 1000.0H	1.0%+3 counts	0.0100
500H	50.00H - 499.99H	0.3%+2 counts	0.0030
50H	5.000H – 49.999H	0.2%+2 counts	0.0020
5H	500.0mH – 4.9999H	0.2%+2 counts	0.0020
500mH	50.00mH – 499.99mH	0.3%+2 counts	0.0100
50mH	5.000mH – 49.999mH	0.5%+3 counts	0.0500
5mH	50μF – 4.999mH	1.4%+5 counts	

■ **1kHz/2kHz**

Range	Display range	Accuracy Le	Accuracy Qe
100H	50.00H –99.99H	1.0%+3 counts	0.0100
50H	5.000H – 49.999H	0.3%+2 counts	0.0030
5H	500.0mH – 4.9999H	0.2%+2 counts	0.0020
500mH	50.00mH – 499.99mH	0.2%+2 counts	0.0100
50mH	5.000mH – 49.999mH	0.2%+2 counts	0.0500
5mH	500.0μH – 4.9999mH	0.5%+3 counts	0.0700
500μH	50.0μH – 499.9μH	1.4%+5 counts	

■ **10kHz**

Range	Display range	Accuracy Le	Accuracy Qe
1000mH	500.0mH – 999.9mH	1.0%+3 counts	0.0100
500mH	50.00mH – 499.99mH	0.2%+2 counts	0.0020
50mH	5.000mH – 49.999mH	0.3%+2 counts	0.0500
5mH	500.00μH – 4.9999mH	0.3%+2 counts	0.0700
500μH	50.00μH – 499.9μH	1.0%+3 counts	0.0800
50μH	5.00μH – 49.99μH	1.4%+5 counts	

■ **50kHz/100kHz**

Range	Display range	Accuracy Le	Accuracy Qe
100mH	50.00mH – 99.99mH	1.2%+5 counts	0.0120
50mH	5.000mH – 49.999mH	1%+2 counts	0.0700
5mH	500.0μH – 4.9999mH	0.65%+2 counts	0.0500
500μH	50.00μH – 499.99μH	0.65%+2 counts	0.0500
50μH	5.000μH – 49.999μH	1%+5 counts	0.0700
5μH	0.500μH – 4.999μH	2.5%+10 counts	

Q's accuracy is defined below:

$$Q_e = \pm \frac{Q_x^2 \times D_e}{1 \mp Q_x \times D_e} \text{ (when } Q_x \times D_e < 1)$$

Where:

Q<sub>x</sub> is the measured Q value.

D<sub>e</sub> is D's accuracy.



## Accuracy Z and $\theta$

■ **<=10kHz**

Range	Display range	Accuracy Ze	Accuracy $\theta$ e
10M $\Omega$	5.000M $\Omega$ - 10.000M $\Omega$	3.0%+5 counts	2.0°
5M $\Omega$	500.0k $\Omega$ - 4.9999M $\Omega$	1.2%+3 counts	0.7°
500k $\Omega$	50.00k $\Omega$ - 499.99k $\Omega$	0.3%+3 counts	0.2°
50k $\Omega$	5.000k $\Omega$ - 49.999k $\Omega$	0.2%+2 counts	0.2°
5k $\Omega$	500.0 $\Omega$ - 4.999k $\Omega$	0.2%+2 counts	0.2°
500 $\Omega$	50.00 - 499.99 $\Omega$	0.2%+2 counts	0.2°
50 $\Omega$	5.000 $\Omega$ - 49.999 $\Omega$	0.3%+3 counts	0.2°
5 $\Omega$	0.5000 $\Omega$ - 4.9999 $\Omega$	0.65%+3 counts	0.6°
0.5 $\Omega$	0.0500 $\Omega$ - 0.4999 $\Omega$	3.0%+3 counts	

■ **>10kHz**

Range	Display range	Accuracy Ze	Accuracy $\theta$ e
5M $\Omega$	500.0k $\Omega$ - 4.9999M $\Omega$	3.0%+10 counts	2.0°
500k $\Omega$	50.00k $\Omega$ - 499.99k $\Omega$	1.2%+5 counts	0.7°
50k $\Omega$	5.000k $\Omega$ - 49.999k $\Omega$	0.3%+2 counts	0.3°
5k $\Omega$	500.0 $\Omega$ - 4.999k $\Omega$	0.2%+2 counts	0.2°
500 $\Omega$	50.00 - 499.99 $\Omega$	0.2%+2 counts	0.2°
50 $\Omega$	5.000 $\Omega$ - 49.999 $\Omega$	0.3%+5 counts	0.3°
5 $\Omega$	0.5000 $\Omega$ - 4.9999 $\Omega$	1%+10 counts	1.0°
0.5 $\Omega$	0.0500 $\Omega$ - 0.4999 $\Omega$	3.0%+20 counts	

## Accuracy ESR and $\Phi$

---

ESR is equal to the series equivalent resistance (Rs)

$$R_{S_e} = \pm X_x \cdot \phi_e [\Omega]$$

Where:  $\theta_e$  is  $\theta$ 's accuracy.

Among them,  $X_x$  is the measured reactance value

$$X_x = 2\pi fL_x \text{ or } X_x = \frac{1}{2\pi fC_x}$$

$$\phi_e = \theta_e \cdot \frac{\pi}{180}$$

Phase Angle Accuracy:

Where:

$L_x$  is the measured L value. [H]

$C_x$  is the measured C value. [F]

$\theta_e$  is  $\theta$ 's accuracy.

Parallel equivalent resistance accuracy formula:

$$R_{p_e} = \pm \frac{R_{p_x} \cdot \phi_e}{D_x \mp \phi_e} [\Omega]$$

Where:

$R_{p_x}$  is the measured Rp value. [ $\Omega$ ]

$D_x$  is the measured D value.

$D_e$  is D's accuracy.

## Accuracy DCR

---

### ■ DCR

Range	Display range	Accuracy
10M $\Omega$	5.000M $\Omega$ - 10.000M $\Omega$	3.0%+5 counts
5M $\Omega$	500.0k $\Omega$ - 4.9999M $\Omega$	1.2%+3 counts
500k $\Omega$	50.00k $\Omega$ - 499.99k $\Omega$	0.3%+3 counts
50k $\Omega$	5.000k $\Omega$ - 49.999k $\Omega$	0.2%+2 counts
5k $\Omega$	500.0 $\Omega$ - 4.999k $\Omega$	0.2%+2 counts
500 $\Omega$	50.00 - 499.99 $\Omega$	0.2%+2 counts
50 $\Omega$	5.000 $\Omega$ - 49.999 $\Omega$	0.3%+3 counts
5 $\Omega$	0.5000 $\Omega$ - 4.9999 $\Omega$	0.65%+3 counts
0.5 $\Omega$	0.0500 $\Omega$ - 0.4999 $\Omega$	3.0%+3 counts

## Dimensions

